



ELITE TRADE & CONTRACT
KITCHENS

FURNITURE HANDLES

INCLUDING PROFILES FOR HANDLE FREE APPLICATIONS



HANDLE COLOUR GUIDE

BLACK

Black handles are a staple for contemporary and modern kitchens. When using brilliant white cabinetry, a matt black knob or pull handle would contrast well here:



GOLD & BRASS

Gold and brass finishes are some of the most popular amongst kitchen designers. Gold is a versatile colour that can be used in a variety of ways to complete the perfect kitchen style. Brass is becoming increasingly popular because of the finish it provides in a dark toned kitchen. Our midnight blue York slab door is the perfect partner for either brass or gold handles. Browse our gold and brass handle range throughout the brochure with our best sellers here:



COPPER

Like gold, copper is very versatile, and like brass matches perfectly with darker colours. A brushed brass finish in a kitchen can also create a stunning impact-finish to those seeking a country or traditional look.

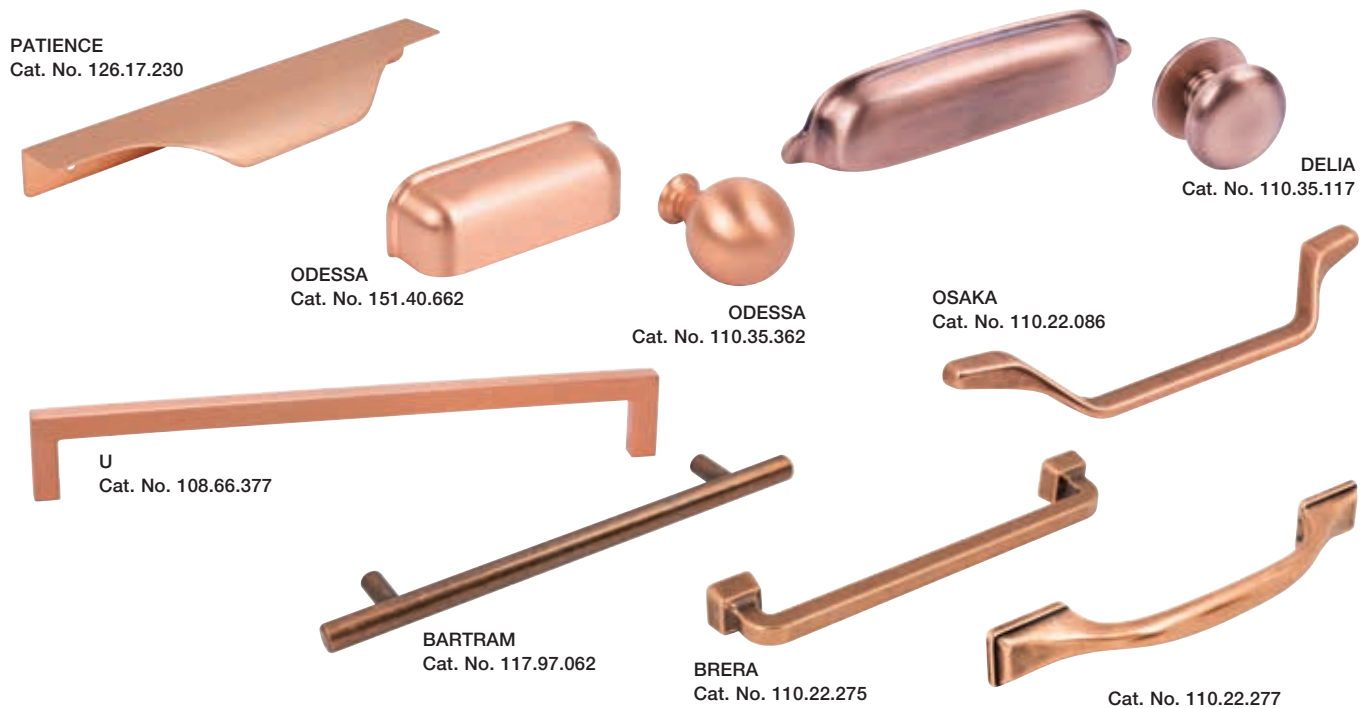

CHROME

Chrome handles are ideal in a modern looking battleship grey kitchen as well as a more traditional white or cream styled kitchen. When used correctly chrome finishes provide a beautiful final touch to the most popular room in the house.





ALICE



K
Page 44

BELLA



K Bed Bath
Pages 44, 217, 277

BARRINGTON



K Bed Bath

K
Page 43



MELINA



K
Page 43



K
Page 44

BESWICK



K
Page 46

INDIA



K
Page 45



PUMA



K Bed Bath
Pages 47, xx, xx

PIMLICO



K Bed
Pages 46, 218

BARTRAM

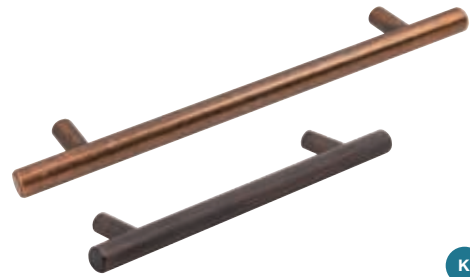

K Bed Bath



recommended applications - Kitchen **K** Bed **Bed**

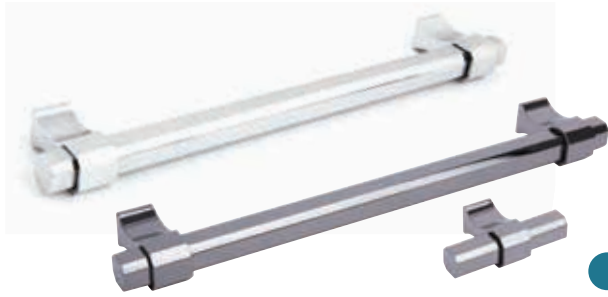

Bath
278



K Bath
Pages 48, 279



TILAA

T. VINCENT



K Bed Bath
Pages 49, 219, 280



K



VENUS



K

Page 51

recommended ap

BAYSWATER



K

Page 53

ORLANA



K

Page 53

BOROS



K

Page 53

CARE & MAINTENANCE



Page 352



K Bed Bath

Pages 54, 220, 281

BEULAH



K

Page 54

CHELSEA



K

Page 55

GIGI



K

Page 55

LYDIATE



K

Page 55

LAUREL



K

Page 56

NUGENT



K

Page 56

INSTALLATION TOOLS



Pages 350-351

recommended applications - Kitchen

K

Bedroom

Bed

Bathroom

Bath

MANDALAY



K

Page 56

D HANDLE, Ø 10 MM



K

Page 57

D HANDLE, Ø 10 MM



K

Page 57

D HANDLE, Ø 10 MM



K

Page 57

D HANDLE, Ø 8 MM

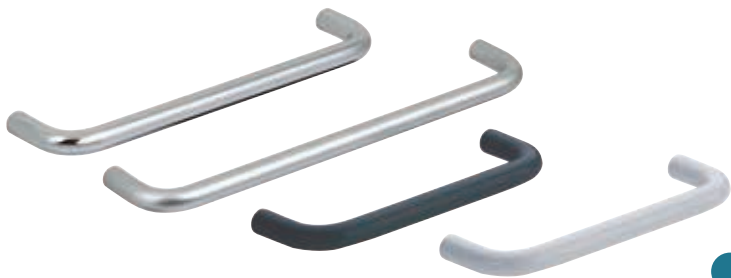

D HANDLE, Ø 8 MM



MUSGRAVE

CONWAY



K

Page 59



K

ARGYLL

LAMA



K

Page 59



K



recommended applications - Kitchen

DUKE



K
Page 61

LEOPOLD



K
Page 61

PEMBRIDGE



K
Page 62

LYLE



K
Page 63

FACTORY



K

BUTTON



K



OSAKA



K **Bed** **Bath**

Pages 66, 221, 282

recommended applications - Kitchen **K**

Bedroom **Bed**

Bathroom **Bath**

Dimensional data not binding. We reserve the right to alter specifications without not.

PUTNEY



K
Page 67



M4 HANDLE SCREWS



Page 353

ARVE



K
Page 68



K
Page 68



K
Page 68

BRONTE



K
Page 69

CARE & MAINTENANCE



Page 352

ENZA



K
Page 69

KESWICK



K
Page 69

MORGAN



K
Page 70

LINCOLN



K
P



AND



K
Page 71

LUELLA



K
Page 71

LARISSA



K
Page 72

BALTIMORE



K **Bath**
Pages 72, 287

HARGRAVE



K
Page 72

recommended applications - Kitchen **K**

Bedroom **Bed**

Bathroom **Bath**

METROPOLIS



K Bath



OASI

JAZZ



K



K Bed



Pages 78

K Bath



Page 79

K



CEYLON

CURLY

SWING



Page 80

K



K

Page 81



K Bath

Pages 81, 287

TONDA



K

Page 81

CARE & MAINTENANCE



Page 352

recommended applications - Kitchen

K

Bedroom

Bed

Bathroom

Bath

ADDA



CONTACT



K

Page 82

K

Page 82



K

Bed

Pages 82, 223

M4 HANDLE SCREWS



Page 353

EROS



K

Page 83

ULTRA



K

Bath

Pages 83, 287

TWIST



K

Bed

Pages 83, 224

INSTALLATION TOOLS



Pages 350-351

recommended applications - Kitchen

K

Bedroom

Bed

Bathroom

Bath

Dimensional data not binding. We reserve the right to alter specifications without notice.



K Bed Bath



K Bed Bath

Pages 85, 227, 289

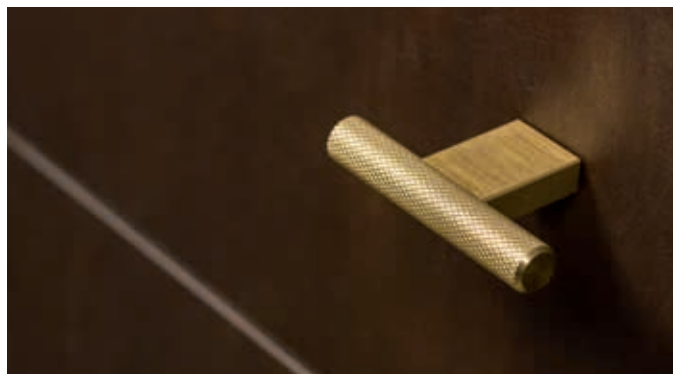

GRAF BIG



K Bed Bath



recommended applications - Kitchen

K

Bedroom

Bed

Bathroom

Bath



FLOID



K



FIRM



K

Page 88



M4 HANDLE SCREWS



Page 353



K Bed Bath



K Bed Bath



K Bed Bath

Pages 89, 229, 291

recommended applications - Kitchen

K

Bedroom

Bed

Bathroom

Bath



K Bed Bath

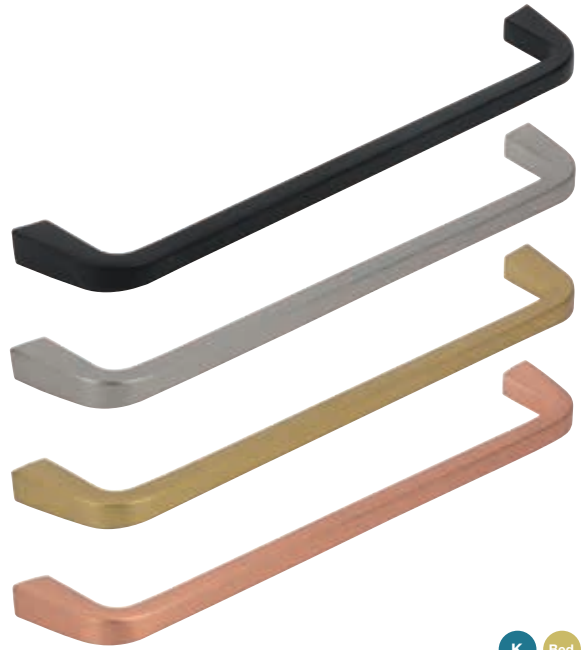

K Bed Bath

OLYMPIA



K

Page 92

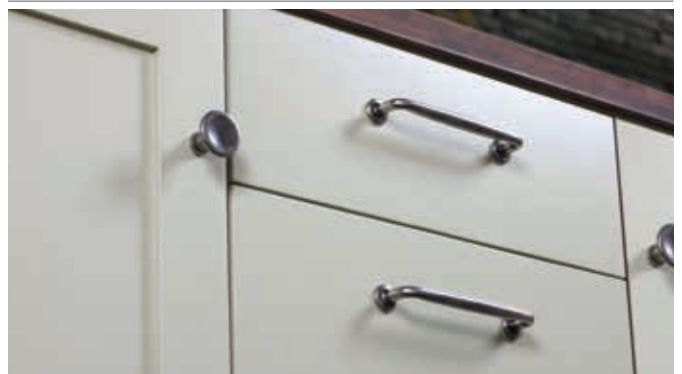

recommended applications - Kitchen

K

Bedroom

Bed

Bathroom

Bath



MAYFAIR



K
Page 93

WARWICK



K
Page 93

HERITAGE



K
Page 94

SALVADOR



K
Page 94

BRERA



K Bath
Pages 95, 295

SHAPES



K
Page 95

INSTALLATION TOOLS



Pages 350-351

THEODORE



K
Page 96



K Bed Bath
Pages 97, 232, 294

recommended applications - Kitchen **K**

Bedroom **Bed**

Bathroom **Bath**

ce.

FURNITU

DEVON



K

Page 98

EMERSON



K Bed Bath

HARRINGTON



K Bath

SAFFRON



K

CALEIDO



K Bath



MONTROSE



K

Page 100



K

Page 101



K

Page 101

BLANCO



K Bed

Pages 102, 233

NOIR



K Bed

Pages 102, 233

DOMINO



K Bed

Pages 102, 233

recommended applications - Kitchen

K

Bedroom

Bed

Bathroom

Bath

CRYSTAL



K Bed Bath

Pages 103, 234, 298

GLACIO



K Bed Bath

Pages 104, 23

BYRON



K Bed Bath

Pages 105, 236, 300



K Bed

Pages 106, 237

DISCO



K Bed

Pages 107, 238

DOTTY



K

Page 108

DIMPLE



K Bed Bath

Pages 108, 239, 302

ANTROBUS



K

Page 109

QUIGLEY



K Bed Bath

Pages 109, 240, 303

OCTAVIA



K Bath

Pages 109, 303

LEWIS



K

Page 110

BELMONT



K

Page 110

recommended applications - Kitchen

K

Bedroom

Bed

Bathroom

Bath

CICERO



K Bath

Pages 110, 304

DARIA



K

Page 111

JACKSON



K

Page 111

CHISWICK



K Bed Bath

Pages 111, 240, 303

TARA



K Bed

Pages 112, 240

EMILY



K

Page 112

SOPHIA



K Bed

Pages 113, 241

SILAS



K Bed

Pages 113, 241

TAVISTOCK



K Bed Bath

FLORENCE



K

INSTALLATION TOOLS



Pages 350-351

MELBURY



K

Page 114

MANILIA



K

Page 115

SABINE



K

Page 115

GRACE



K

Page 116

AUBREY



K Bed

Pages 116, 242

REMUS



K

Page 116

KAYLA



K

Page 117

recommended applications - Kitchen

K

Bedroom

Bed

Bathroom

Bath



LOGAN



P



ARCO



Pages 118, 243

INDIGO



Pages 119, 244, 305

BRADLEY



Page 117

BOW HANDLE

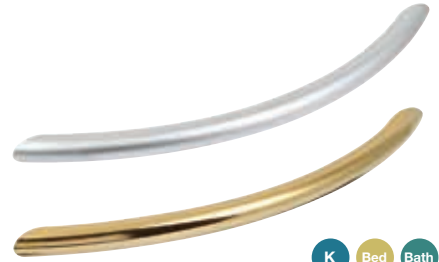

Pages 119, 244, 305

CEDAR



Page 120

CLIFTON



Pages 120, 244, 305

ELMER



Page 121

M4 HANDLE SCREWS



Page 353

HUDSON



CORDELIA



Pages 121, 245, 307

recommended applications - Kitchen



Bedroom



Bathroom



Dimensional data not binding. We reserve the right to alter specifications without notice.

AT A GLANCE

KITCHEN APPLICATIONS

PLICATIONS

ICA

INSTALLATIO

RAVIOLO



K

Page 122

HENLEY



K Bed Bath

Pages 123, 242, 304



FABIAN



K

Page 124

NORFOLK



K

Page 124

SHERWOOD



K

Page 124

TAPER



K

Page 125

KNIGHTSBRIDGE



K Bed

Pages 126, 2

KNIGHTSBRIDGE



K Bed

Pages 126, 246

ROCHDALE



K

Page 127

recommended applications - Kitchen

K

Bedroom

Bed

Bathroom

Bath

HENRIETTA



K Bed Bath

Pages 128, 2



ARIEL



K Bed Bath

Pages 129, 248, 30

BLACK NICKEL

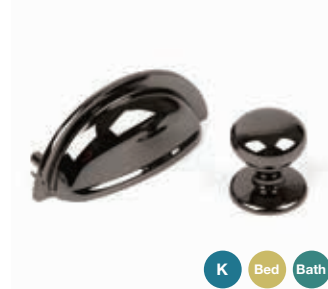

K Bed Bath

Pages 128, 133, 247, 308

ODESSA



K Bed Bath

Pages 130-131, 250-251

STORATION



K

Page 132



MAYBERRY



K



K

Page 133



K Bed

Pages 134-135, 252-253

recommended applications - Kitchen

K

Bedroom

Bed

Bathroom

Bath

SMOOTH



Pa

K



K

BOLD



K

Page 138



KANE



K Bed Bath

Pages 139, 254, 316

DELIA



K Bath

Pages 140, 31

JUDE



K Bath

Pages 141, 313

recommended applications - Kitchen

K

Bedroom

Bed

Bathroom

Bath

LAMONT



K



CONWY

CONWY



K

Page 148



K

Page 148



K

Bath

IRONBRIDGE & RIO

IRONBRIDGE & CONWY

QUESLETT



K

Pages 146, 101



K

Pages 147, 148



K

Page 150

recommended applications - Kitchen

K

Bedroom

Bed

Bathroom

Bath



K

Page 151



CRAWFORD



K Bed Bath

Pages 153, 255, 317

recommended applications - Kitchen

K

Bedroom

Bed

Bathroom

Bath



K Bed
Pages 154, 256

COTSWOLD

COTSWOLD

COTSWOLD

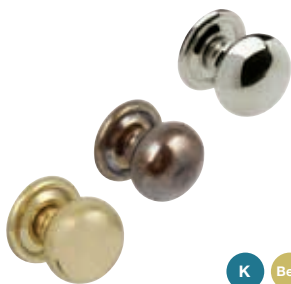

K Bed
Pages 155, 257



K Bed
Pages 155, 257



K Bed
Pages 155, 257

EGG TIMER

BINX

LEO

ORSON



K Bath
Pages 156, 318



K
Page 156



K
Page 156



K
Page 156

BEUVRON

CORMOR

DEXTER

AMBER



K
Page 157



K
Page 157



K
Page 157



K Bed Bath
Pages 158, 258, 318

recommended applications - Kitchen



Bedroom



Bathroom



LARA



K

Page 158

FLYNN



K

Page 158

OVAL



K

Page 159

ORIEL



K Bed Bath

Pages 159, 258, 319

CASSIUS



K

Page 159

AMELIA



K Bath

Pages 160, 319

ASPEN



K

Page 160

BIANCA



K

Page 160

CLEO



K

Page 161

COCO



K

Page 161

FLOYD



K

Page 161

RUGBY



K

Page 162

CLAYTON



K

Page 162

CORRINE



K

Page 162

GROSVENOR



K

Pages 163, 258

M4 HANDLE SCREWS



Page 353

ROCHER



K Bed Bath

Pages 164, 260, 320

BALLEY



K Bath

Pages 164, 320

SULA



K



Rocher knob shown on round backplate - Page xxx

recommended applications - Kitchen

K

Bedroom

Bed

Bathroom

Bath

JUPITER



K Bed Bath

Pages 166, 262, 318



K

VICTORIA



K Bed

Pages 167, 262

CALVIN



K

Page 167



K

CROSS GRAIN



VICTORIAN - CROSS GRAIN



K

Page 170

CROSS GRAIN



K

Page 168

CROSS GRAIN



K

Page 170

END GRAIN



TURNED - END GRAIN



K Bed

Pages 168, 263

TURNED - END GRAIN



K

Page 169

WOOD TREATMENTS



Visit www.bushbros.co.uk

TURNED - END GRAIN



K

Page 169

TURNED - END GRAIN



K

Page 169

TURNED - END GRAIN



K

Page 170

recommended applications - Kitchen

K

Bedroom

Bed

Bathroom

Bath



K

Page 171

CADOGAN



K

Page 171



SHAKER



K

HARLEY



K Bed Bath

Pages 172, 264, 322

DIAMOND

PRIMROSE



K Bed

Pages 172, 264



K Bed

Pages 172, 264



recommended applications - Kitchen

K

Bedroom

Bed

Bathroom

Bath

ESTE & COMO



Pages 91, 231, 293



COMO



K Bed Bath

Pages 173, 265, 323

INSTALLATION TOOLS



Pages 350-351

PEARL

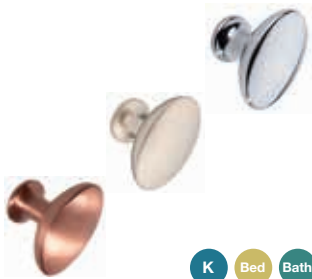

K Bed Bath

Pages 172, 264, 322

ACER



K Bath

Pages 174, 324

CYRUS



K

Page 174

JONQUIL



K

Page 174

ACACIA



K Bath

Pages 174, 324

CHLOEU



K Bed Bath

Pages 175, 266, 325

KEW



K Bed Bath

Pages 175, 266, 325

CONSTANCE



K Bed Bath

Pages 175, 266, 325

recommended applications - Kitchen

K

Bedroom

Bed

Bathroom

Bath

Dimensional data not binding. We reserve the right to alter specifications without notice.



OBERON



K Bed Bath

Pages 176, 267, 326

ORBUSIER



K Bath

Pages 177, 327

CARE & MAINTENANCE



Page 352

LUCA



K

Page 177

LUCA



K

Page 177

GEMINI



K

Page 178

ANGUS



K Bath

Pages 178, 327

ALBANO



K

Page 180

CARTON



K

Page 180

CHESTER



K

Page 180

HELENE



K

Page 180

POLKA



K

Page 181

SORENTO



K

Page 181

recommended applications - Kitchen

K

Bedroom

Bed

Bathroom

Bath

TAMARA



K

Page 181

TAURION



K

Page 181

EDEN



K

Page 182

BRUNSWICK



K

Page 182

BUXTON



K

Page 182

SAVANNAH



K

Page 183

SYON



K

Page 183

ARCADIA



K

Page 183

CAXTON



K

Page 186

CAXTON



K

Page 186

ARGENTON



K

Page 187

RISLE



K

Page 187

TWISTER



K Bed

Pages 184-185,



CURVE



K

Page 188



MADDOX



K

Page 189

ELLA



K

Page 189

QUINN



K

Page 189

FINN



K

Page 190

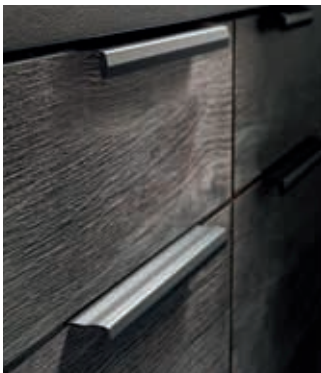

LINE



K Bed Bath

LISTER



K Bed Bath

Pages 190, 270, 328

CALAVON



K

Page 192

ONA



K

Page 191



PORTOBELLO



K

Page 192

recommended applications - Kitchen

K

Bedroom

Bed

Bathroom

Bath

SAANE



K

Page 192

LAMONE



K

Page 193

ATTIS



K

Page 193

CIRON



K

Page 193

LIBRA



K

Bed

Pages 194,

AVELINE



K

Page 195

ELVO



K

Page 195

ANGLE



K

Bed

Bath

Pages 196, 272, 329

M4 HANDLE SCREWS



Page 353



ALLEGRA



K

Page 197

AZALEA



K

Page 197

OXFORD



K

Bath

Pages 197, 328

CARE & MAINTENANCE



Page 352

recommended applications - Kitchen

K

Bedroom

Bed

Bathroom

Bath



NOMA



K Bath



NICK



K Bath

Pages 198, 330



PATIENCE



K Bath

Pages 200, 332

RITTA



K Bath

Pages 201, 33



recommended applications - Kitchen

K

Bedroom

Bed

Bathroom

Bath



K

RAIL



K

Page 203

INSTALLATION TOOLS



Pages 350-351



RUBY

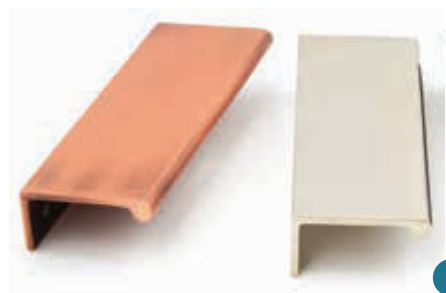

K

Bed

Bath

Pages 203, 270, 332

M4 HANDLE SCREWS



Page 353

CARE & MAINTENANCE



Page 352

recommended applications - Kitchen

K

Bedroom

Bed

Bathroom

Bath

Dimensional data not binding. We reserve the right to alter specifications without notice.

SAUL



K
Page 204

MAGNUS



K
Page 20

AARON



K
Page 205

EPTE



K
Page 20



INDRE



K
Page 205

MONTONE



K
Page 206

HALKIN



K
Page 206

VIENNE



K
Page 207

AVEBURY



K
Page 207

CAVU



K
Page 207

ROYA



K
Page 208

AROS



K
Page 208

BESBRE



K
Page 208

M4 HANDLE SCREWS



Page 353

recommended applications - Kitchen **K**

Bedroom **Bed**

Bathroom **Bath**

RHIN



K Bed

Pages 209, 274

AUTHIE



K

Page 20

CAVENDISH



K Bed



BLAVET



K

MAINE



K Bed



K Bed

Pages 275

SINTESI



K



K



K

PELLIPAR



K

Page 213

CARE & MAINTENANCE



Page 352



recommended applications - Kitchen

K

Bedroom

Bed

Bathroom

Bath



Aspekt cabinet doors from - Skye gloss dove grey featured with stainless steel bar handles

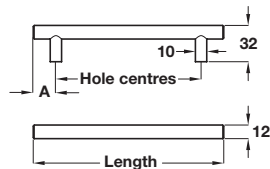

- > *2 each of M4 x 45 mm snap off handle screws included (101.20.700 includes an additional 1x M4 x 25 mm screw)
- > Order M4 handle screws separately
- > Steel
- > Order qty: 1 pc



		res	Dim. A	Cat. No.
 Stainless steel effect	136 mm	96 mm	20 mm	101.20.709
	168 mm	128 mm	20 mm	101.20.700*
	226 mm	156 mm	35 mm	101.20.701*
	230 mm	160 mm	35 mm	101.20.710*
	232 mm	192 mm	20 mm	101.20.708
	326 mm	256 mm	35 mm	101.20.702*
	376 mm	306 mm	35 mm	101.20.703*
	426 mm	356 mm	35 mm	101.20.704
	526 mm	456 mm	35 mm	101.20.705
	702 mm	632 mm	35 mm	101.20.706
828 mm	758 mm	35 mm	101.20.707*	

+ View the full Aspekt cabinet doors range, visit www. .co.uk/aspekt-doors

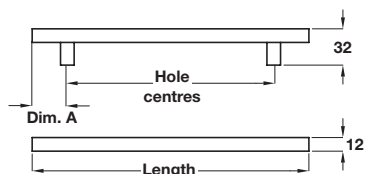

BARRINGTON bar handle, Ø 12 mm

- > Order M4 handle screws separately
- > Steel handle, stainless steel effect
- > Order qty: 1 pc



		entres	Dim. A	Cat. No.
 Stainless steel effect	156 mm	96 mm	30 mm	103.46.601
	188 mm	128 mm	30 mm	103.46.602
	219 mm	160 mm	30 mm	103.46.603
	244 mm	184 mm	30 mm	103.46.604
	294 mm	234 mm	30 mm	103.46.605
	344 mm	284 mm	30 mm	103.46.606
	394 mm	334 mm	30 mm	103.46.607
	444 mm	284 mm	30 mm	103.46.608
	494 mm	434 mm	30 mm	103.46.609
	510 mm	450 mm	30 mm	103.46.610
	544 mm	484 mm	30 mm	103.46.611
	579 mm	519 mm	30 mm	103.46.612
	655 mm	595 mm	30 mm	103.46.613
	706 mm	646 mm	30 mm	103.46.614
	835 mm	775 mm	30 mm	103.46.615
844 mm	784 mm	30 mm	103.46.616	
920 mm	860 mm	30 mm	103.46.617	
Additional centre support				
	967 mm	907 mm	30 mm	103.47.601

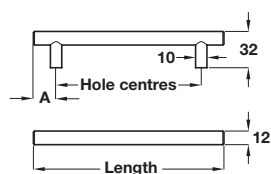

BARNABUS bar handle, Ø 12 mm

- > 2 each of M4 x 45 mm snap off handle screws included (117.67.642* includes an additional 1x M4 x 45 mm screw)
- > Steel
- > Order qty: 1 pc



		entres	Dim. A	Cat. No.	
 Stainless steel effect	188 mm	128 mm	30 mm	103.46.601	
	237 mm	177 mm	30 mm	103.46.602	
	337 mm	277 mm	30 mm	103.46.603	
	387 mm	327 mm	30 mm	103.46.604	
	437 mm	377 mm	30 mm	103.46.605	
	510 mm	450 mm	30 mm	103.46.606	
	537 mm	477 mm	30 mm	103.46.607	
	655 mm	595 mm	30 mm	103.46.608	
	835 mm	775 mm	30 mm	103.46.609	
	Additional centre support				
		1185 mm	560 mm	32.5 mm	103.47.601

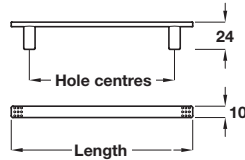

MELINA pull handle

- > Order M4 handle screws separately
- > Zinc alloy
- > Order qty: 1 pc



		ole centres	Cat. No.
Polished chrome	161.5 mm	128 mm	111.38.222
	193.5 mm	160 mm	111.38.223
	257.5 mm	224 mm	111.38.225

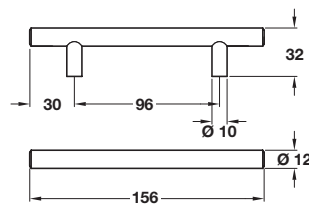

Not for use on load bearing doors such as appliances

ALICE bar handle, Ø 12 mm

- > 2x M4 x 45 mm snap off handle screws included
- > Steel
- > Order qty: 1 pc



	Cat. No.
Polished chrome	117.97.250

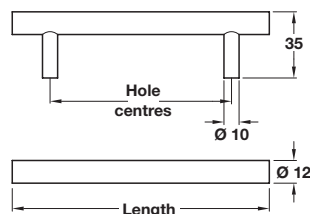

BELLA bar handle, Ø 12 mm

- > Order M4 handle screws separately
- > Steel
- > Order qty: 1 pc



	ength	Hole centres	Cat. No.
Polished chrome	136 mm	96 mm	117.97.224
	168 mm	128 mm	117.97.225
	200 mm	160 mm	117.97.218
	232 mm	192 mm	117.97.227
	328 mm	288 mm	117.97.219
	392 mm	352 mm	117.97.229



Don't forget to order M4 handle screws, see page **353**

For our full range of fixing materials and installation tools see the Installation & Display section, pages **350-353**

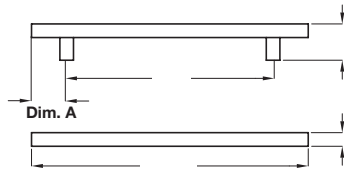

BESWICK bar handle, Ø 12 mm

- > Order M4 handle screws separately
- > Please note: maximum bolt length = 28 mm + board thickness
- > Steel handle with brass feet
- > Order qty: 1 pc



		ntres	Dim. A	Cat. No.
Polished chrome-plated	156 mm	96 mm	30 mm	117.52.201
	188 mm	128 mm	30 mm	117.52.202
	244 mm	184 mm	30 mm	117.52.204

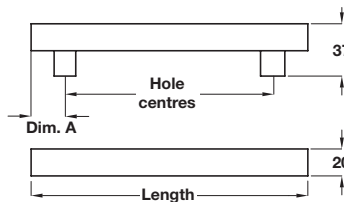

INDIA bar handle, Ø 20 mm

- > Order M4 handle screws separately
- > Stainless steel
- > Order qty: 1 pc



		entres	Dim. A	Cat. No.
Stainless steel effect	188 mm	128 mm	30 mm	107.64.002
	220 mm	160 mm	30 mm	107.64.003
	344 mm	284 mm	30 mm	107.64.006
	544 mm	484 mm	30 mm	107.64.011
	655 mm	595 mm	30 mm	107.64.013
With additional centre support				
	835 mm	775 mm	30 mm	107.64.015

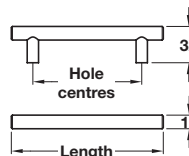

BARTRAM bar handle

- > *2x M4 x 20 mm, 2x M4 x 22 mm and 2x M4 x 25 mm screws included
- > Steel



			Cat. No.
Polished	178 mm	128 mm	117.97.062
	220 mm	160 mm	117.97.063*
Brushed oil rubbed bronze	178 mm	128 mm	117.97.162
	220 mm	160 mm	117.97.163

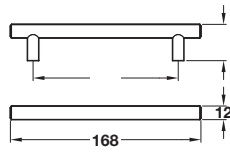

	No.
 Matt black epoxy	101.20.325

Pimlico

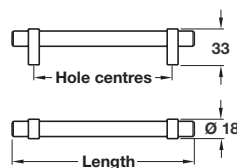

PIMLICO bar handle

- > Order M4 handle screws separately
- > Steel bar with zinc alloy feet
- > Order qty: 1 pc



		entres	Cat. No.
 Stainless steel effect	168 mm	128 mm	115.66.045
	232 mm	192 mm	115.66.045
	264 mm	224 mm	115.66.047
	424 mm	384 mm	115.66.048

Tiberius



Aspekt cabinet doors from [] - York matt slate grey featured with Tiberius bar handles in polished chrome finish

View the full Aspekt cabinet doors range, visit [www.\[\].co.uk/aspekt-doors](http://www.[].co.uk/aspekt-doors)

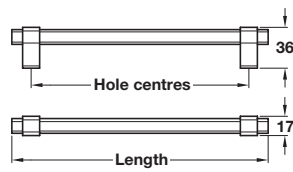

TIBERIUS bar handle

- > 2x M4 x 25 mm handle screws included
- > Aluminium



			at. No.
			2.85.050
			2.85.051
	195 mm	160 mm	112.85.071

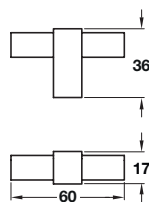

TIBERIUS T knob

- > 1x M4 x 25 mm handle screw included
- > Aluminium
- > Order qty: 1 pc



	Cat. No.
	112.85.095

Carrione

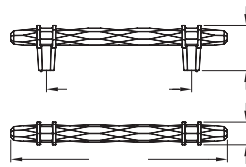

*Product is subject to variations in finish due to the finishing and manufacturing process of certain materials

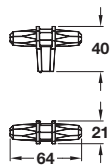

*Product is subject to variations in finish due to the finishing and manufacturing process of certain materials

CARRIONE pull handle

- > 2x 8/32 x 1" (non-metric) screws included
- > Zinc alloy
- > Order qty: 1 pc



	Length	Hole centres	Cat. No.
	160 mm	96 mm	133.53.035
	191 mm	128 mm	133.53.036
	160 mm	96 mm	133.53.037
	191 mm	128 mm	133.53.038



T knob

1" (non-metric) screw included

- > Zinc alloy
- > Order qty: 1 pc



	Cat. No.
polished nickel	133.53.033
Marble white / Oil rubbed bronze*	133.53.034



All handles on this page include 8/32 x 1" (non-metric) screws. If you require a different length order non-metric cut off screw Cat. No. 022.24.881 shown on page **353**

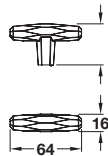
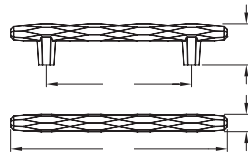



	Cat. No.
	133.50.641
	133.50.639

Golden champagne



Don't forget to order M4 handle screws, see page **353**

For our full range of fixing materials and installation tools see the Installation & Display section, pages **350-353**

Tilaa

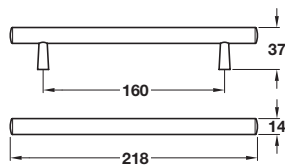



Product is subject to variations in colour and dimensions due to being manufactured from natural materials

TILAA bar handle

- > 2x M4 x 30 mm handle screws included
- > *Order M4 handles screws separately
- > Oak or walnut and copper



	Cat. No.
 er	193.18.426
 Walnut / Copper	193.18.736*

Dimensional data not binding



VENUS pull handle

- > Order M4 handle screws separately
- > Oak, lacquered
- > Order qty: 1 pc

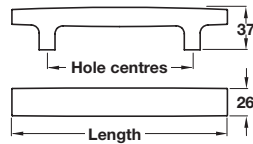

	Length	Hole centres	Cat. No.
	190 mm	128 mm	193.18.430
Lacquered oak	316 mm	224 mm	193.18.431

Product is subject to variations in colour and dimensions due to being manufactured from natural materials



BESPOKE TIMBER DRAWERS

Kitchen drawers are becoming an increasingly popular alternative to traditional cabinets. Our drawer range and finishes, including a handcrafted



Walnut



Ply

Our Bespoke Timber Drawers are handmade in the UK from high grade solid timber. There are a number of design and personalisation choices available including a choice of wood types and come complete with dove-tailed joints.



Oak

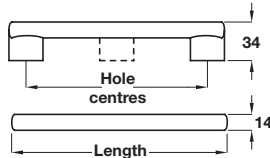

BAYSWATER bar handle

- > Order M4 handle screws separately
- > Brushed stainless steel bar with stainless steel effect zinc alloy feet
- > Order qty: 1 pc



		Hole centres	Cat. No.
 Brushed stainless steel / Stainless steel effect	190 mm	160 mm	108.64.002
	222 mm	192 mm	108.64.003
	254 mm	224 mm	108.64.000
	318 mm	288 mm	108.64.005
	478 mm	448 mm	108.64.008

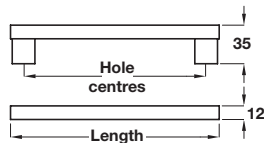

ORLANA bar handle

- > Order M4 handle screws separately
- > Zinc alloy feet in a satin brushed finish, with brushed satin stainless steel bar
- > Order qty: 1 pc



		le centres	Cat. No.
 Satin brushed / Brushed satin stainless steel	150 mm	128 mm	155.01.470
	182 mm	160 mm	155.01.471
	214 mm	192 mm	155.01.472
	310 mm	288 mm	155.01.473
	342 mm	320 mm	155.01.474
	514 mm	492 mm	155.01.475
	814 mm	792 mm	155.01.476

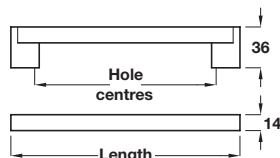

BOROS boss bar handle

- > Order M4 handle screws separately
- > Steel bar with zinc alloy feet
- > Order qty: 1 pc



		Hole centres	Cat. No.
 Stainless steel effect	170 mm	128 mm	108.63.001
	202 mm	160 mm	108.63.002
	234 mm	192 mm	108.63.003
	298 mm	256 mm	108.63.004
	362 mm	320 mm	108.63.006
	490 mm	448 mm	108.63.008



Don't forget to order M4 handle screws, see page **353**
 For our full range of fixing materials and installation tools see the Installation & Display section, pages **350-353**



BOSTON boss bar handle

- > Order M4 handle screws separately
- > *2x M4 x 25 mm, 2x M4 x 25 mm and 2x M4 x 28 mm screws included
- > Zinc alloy ends, with hollow stainless steel tube or solid steel bar
- > Order qty: 1 pc



	Hole centres		Cat. No.
 Stainless steel effect	Hollow stainless steel tube		
	156 mm	128 mm	115.69.002
	188 mm	160 mm	115.69.003*
	220 mm	192 mm	115.69.004
	237 mm	209 mm	104.74.011
	284 mm	256 mm	115.69.006
	337 mm	309 mm	104.74.012
	348 mm	320 mm	115.69.008
	387 mm	359 mm	104.74.013
	437 mm	409 mm	104.74.014
	476 mm	448 mm	115.69.009
	537 mm	509 mm	104.74.015
Solid steel bar			
751 mm	709 mm	104.74.016	
849 mm	807 mm	104.74.017	
951 mm	909 mm	104.74.018	
1199 mm	1157 mm	104.74.019	

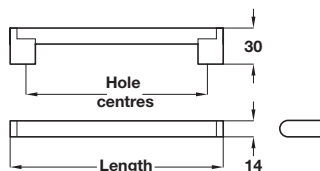

BEULAH boss bar handle

- > Order M4 handle screws separately
- > *2x M4 x 45 mm snap off screws included
- > Zinc alloy ends in a stainless steel finish, with hollow stainless steel tube
- > Order qty: 1 pc



	Hole centres		Cat. No.
 Polished chrome	156 mm	128 mm	104.74.030*
	188 mm	160 mm	104.74.031
	237 mm	209 mm	104.74.032
	316 mm	288 mm	104.74.033*
	337 mm	309 mm	104.74.034
	387 mm	359 mm	104.74.035
	437 mm	409 mm	104.74.036
	476 mm	448 mm	104.74.037
	537 mm	509 mm	104.74.038
	636 mm	608 mm	104.74.039
	751 mm	709 mm	104.74.040
	849 mm	807 mm	104.74.041
	937 mm	909 mm	104.74.042

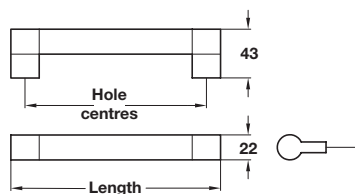

CHELSEA keyhole bar handle, Ø 22 mm

- > Order M4 handle screws separately
- > Zinc alloy ends with stainless steel tube, in a stainless steel effect finish
- > Order qty: 1 pc



		Hole centres	Cat. No.
Polished chrome	153 mm	128 mm	115.69.012
	185 mm	160 mm	115.69.013
	281 mm	256 mm	115.69.016
	381 mm	356 mm	115.69.017
	537 mm	512 mm	115.69.018
	657 mm	632 mm	115.69.019

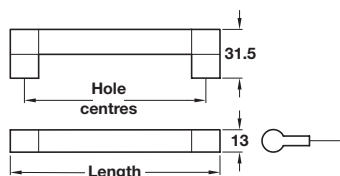

GIGI keyhole bar handle

- > Order M4 handle screws separately
- > Zinc alloy ends in a stainless steel finish, with stainless steel tube
- > Order qty: 1 pc



		Hole centres	Cat. No.
Stainless steel	205 mm	192 mm	115.69.027

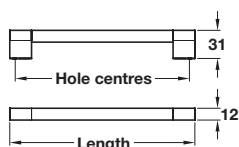

LYDIATE keyhole bar handle, Ø 12 mm

- > Order M4 handle screws separately
- > Brushed stainless steel bar with polished chrome zinc alloy ends
- > Order qty: 1 pc



		Hole centres	Cat. No.
Brushed st. steel	173 mm	160 mm	115.69.056
	204 mm	192 mm	101.24.007



Don't forget to order M4 handle screws, see page **353**

For our full range of fixing materials and installation tools see the Installation & Display section, pages **350-353**

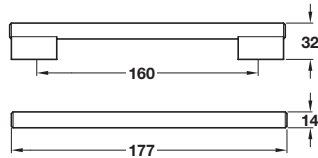

LAUREL bar handle

- > Order M4 handle screws separately
- > Zinc alloy feet and stainless steel bar
- > Order qty: 1 pc



	Cat. No.
 Stainless steel effect	107.46.665

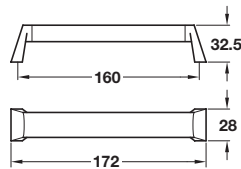

NUGENT angled boss bar handle

- > Order M4 handle screws separately
- > Zinc alloy feet and stainless steel bar



	Cat. No.
 Stainless steel effect	104.74.006

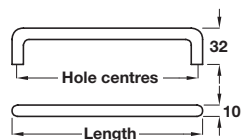

MANDALAY D handle

- > Order M4 handle screws separately
- > *2x M4 x 25 mm handle screws included



		res	Cat. No.
 Brushed stainless steel	74 mm	64 mm	117.40.613
	106 mm	96 mm	117.40.622
	138 mm	128 mm	117.40.631*
	170 mm	160 mm	117.40.640
	298 mm	288 mm	117.40.659
	362 mm	352 mm	117.40.668

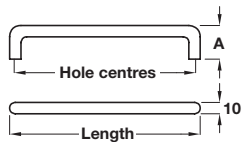

D handle, Ø 10 mm

- > Order M4 handle screws separately
- > Steel



			m. A	Cat. No.
			mm	116.09.015
			mm	116.09.085
	106 mm	96 mm	28 mm	116.09.615
	138 mm	128 mm	28 mm	116.09.685

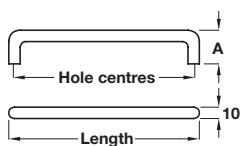

D handle, Ø 10 mm

- > Order M4 handle screws separately
- > Steel
- > Order qty: 1 pc



		Hole centres	Dim. A	Cat. No.
		96 mm	28 mm	116.09.214
		96 mm	32 mm	109.66.201
		128 mm	28 mm	116.09.285
	106 mm	96 mm	28 mm	106.45.301
	138 mm	128 mm	28 mm	106.45.302

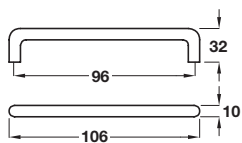

D handle, Ø 10 mm

- > Order M4 handle screws separately
- > Anodised aluminium
- > Order qty: 1 pc



	Cat. No.
 Silver coloured	116.05.941

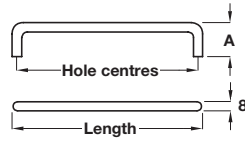

Don't forget to order M4 handle screws, see page **353**
 For our full range of fixing materials and installation tools see the Installation & Display section, pages **350-353**

**D handle, Ø 8 mm**

- > Order M4 handle screws separately
- > Steel

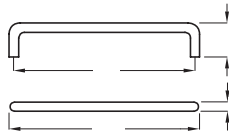

				Cat. No.
				16.07.225
				16.07.244
				06.44.204
				06.44.207
 Aluminium coloured	104 mm	96 mm	30 mm	106.44.402
	136 mm	128 mm	30 mm	106.44.403
	168 mm	160 mm	30 mm	106.44.404
	200 mm	192 mm	28 mm	106.44.405
		56 mm	28 mm	106.44.407
		20 mm	28 mm	106.44.409
		48 mm	30 mm	106.44.413
		28 mm	28 mm	106.44.303
 White	104 mm	96 mm	28 mm	106.44.702
	136 mm	128 mm	28 mm	106.44.703

**D handle, Ø 8 mm**

	Cat. No.
 Matt nickel-plated	155.00.914



Don't forget to order M4 handle screws, see page **353**

For our full range of fixing materials and installation tools see the Installation & Display section, pages **350-353**

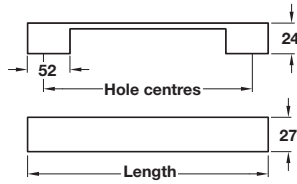

MUSGRAVE D handle

- > Order M4 handle screws separately
- > Aluminium



			Cat. No.
Stainless steel effect	217 mm	192 mm	112.90.014
	281 mm	256 mm	112.90.006

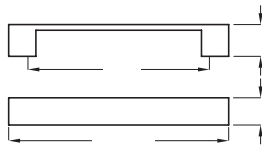

CONWAY D handle

- > Order M4 handle screws separately
- > Aluminium
- > Order qty: 1 pc



		Hole centres	Cat. No.
Stainless steel effect		160 mm	111.34.253
		192 mm	111.34.264
Stainless steel effect	194 mm	160 mm	111.34.053
	226 mm	192 mm	111.34.064

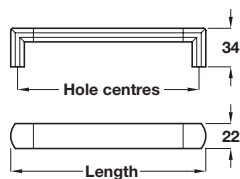

ARGYLL D handle

- > Order M4 handle screws separately
- > Zinc alloy feet with aluminium bar
- > Order qty: 1 pc



		entres	Cat. No.
Stainless steel effect	140 mm	128 mm	113.50.602
	172 mm	160 mm	113.50.603
	236 mm	224 mm	113.50.605
	332 mm	320 mm	113.50.608

Lama



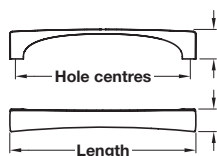

Front view showing handle is curved along the bottom edge



> 2x M4 x 30 mm handles screws included



			Cat. No.
			10.22.296
			10.22.299
 Graphite	170 mm	160 mm	110.22.596
	330 mm	320 mm	110.22.599

Dimensional data not binding. We reserve the right to alter specifications without notice.

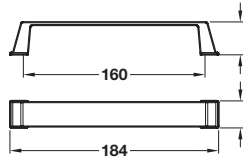

DUKE pull handle

- > Order M4 handle screws separately
- > Zinc alloy



	Cat. No.
 Graphite	111.34.506

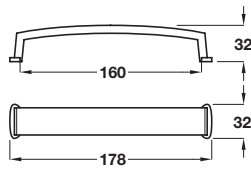

LEOPOLD D handle

- > Order M4 handle screws separately
- > Aluminium
- > Order qty: 1 pc





	Cat. No.
 Stainless steel effect	106.92.604

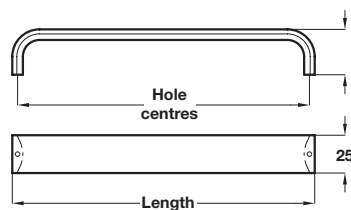

Don't forget to order M4 handle screws, see page **353**
 For our full range of fixing materials and installation tools see the Installation & Display section, pages **350-353**



	36 mm	128 mm	116.04.225
	00 mm	192 mm	116.04.227
	28 mm	320 mm	116.04.228
	136 mm	128 mm	116.04.625
Stainless steel effect	200 mm	192 mm	116.04.627
	328 mm	320 mm	116.04.628

Lyle

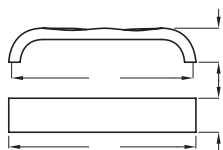

LYLE pull handle

- > Order M4 handle screws separately
- > Zinc alloy
- > Order qty: 1 pc



	Cat. No.
 Polished chrome	107.89.233

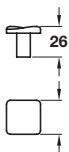

LYLE knob

- > Order M4 handle screws separately
- > Zinc alloy
- > Order qty: 1 pc



	Cat. No.
 Polished chrome	133.26.230

Dimensional data not binding. We reserve the right to alter specifications without notice.



Don't forget to order M4 handle screws, see page **353**

For our full range of fixing materials and installation tools see the Installation & Display section, pages **350-353**



Button



AT A GLANCE

KITCHEN APPLICATIONS

BEDROOM APPLICATIONS

BATHROOM APPLICATIONS

HANDLE FREE APPLICATIONS

INSTALLATION & DISPLAY

Dimensional data not binding. We reserve the right to alter specifications without notice.



BUTTON D handle

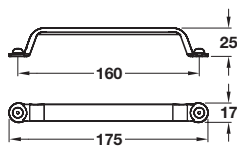

	Cat. No.
	106.69.691
	106.69.692
	69.693
Matt black	106.69.694



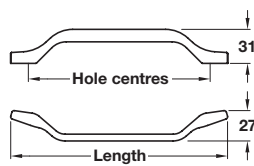

Osaka



OSAKA pull handle

- > Fixings included:
 - Satin brass - 2x M4 x 50 mm snap-off handle screws
 - Antique copper and graphite - 2 each of M4 x 22 mm and M4 x 26 mm handle screws
- > Zinc alloy
- > Order qty: 1 pc



		entres	Cat. No.
	mm	96 mm	110.22.080
	mm	160 mm	110.22.081
	191 mm	160 mm	110.22.086
	351 mm	320 mm	110.22.089
 Graphite	191 mm	160 mm	110.22.586



Putney



AT A GLANCE

KITCHEN APPLICATIONS

BEDROOM APPLICATIONS

BATHROOM APPLICATIONS

HANDLE FREE APPLICATIONS

INSTALLATION & DISPLAY

Dimensional data not binding. We reserve the right to alter

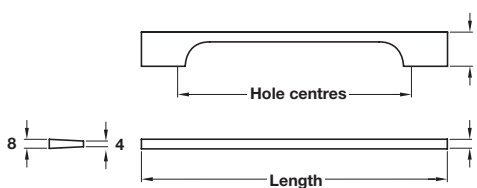

PUTNEY pull handle

> 2x M4 x 45 mm snap off screws included



			Cat. No.
			09.48.207
			09.48.209
 Stainless steel effect	256 mm	192 mm	109.48.607
	352 mm	288 mm	109.48.609

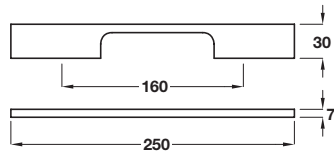
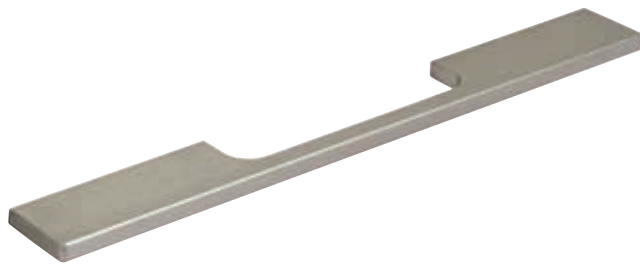

			112.62.203
	Stainless steel effect		112.62.003

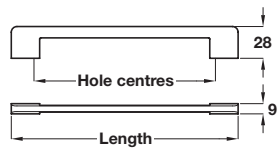

MALVAN D handle

> Order M4 handle screws separately



			. No.
	345 mm	320 mm	110.28.038

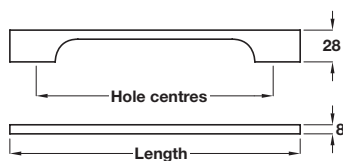

BIOKO pull handle

> 2x M4 handle screws included
> Aluminium

			t. No.
	256 mm	192 mm	111.64.234
	352 mm	288 mm	111.64.237



Don't forget to order M4 handle screws, see page **353**
For our full range of fixing materials and installation tools see the Installation & Display section, pages **350-353**

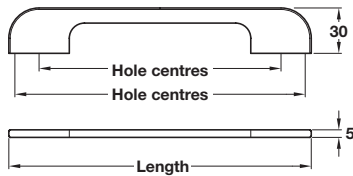

BRONTE D handle

- > Order M4 handle screws separately
- > Zinc alloy



			at. No.
Polished chrome	200 mm	160/192 mm	113.96.246
	330 mm	288/320 mm	113.96.249

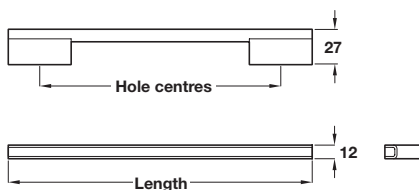

ENZA bar handle

- > Order M4 handle screws separately
- > Aluminium, polished chrome body, with stainless steel effect insert
- > Order qty: 1 pc



	Length	Hole centres	Cat. No.
Polished chrome / Stainless steel effect	268 mm	256 mm	108.94.276

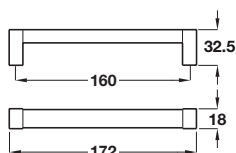

KESWICK square D handle

- > Order M4 handle screws separately
- > Zinc alloy feet with aluminium tube
- > Order qty: 1 pc



	Cat. No.
Stainless steel effect	102.12.056

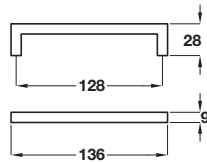

MORGAN D handle

- > Order M4 handle screws separately
- > Zinc alloy
- > Order qty: 1 pc



	Cat. No.
Polished chrome	102.12.232



BESPOKE TIMBER DRAWERS

Kitchen drawers are becoming an increasingly popular alternative to traditional cabinets. Our drawer range and finishes, including a handcrafted



Walnut



Ply

Our Bespoke Timber Drawers are handmade in the UK from high grade solid timber. There are a number of design and personalisation choices available including a choice of wood types and come complete with dove-tailed joints.



Oak

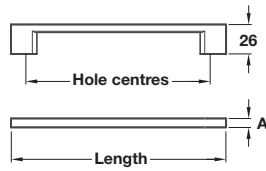

LINCOLN D handle

> Order M4 handle screws separately



			A	Cat. No.
			m	107.03.244
			m	107.24.246
				107.24.247
				107.24.248
				107.24.249
Stainless steel effect	113 mm	96 mm	7.5 mm	107.03.644
	189 mm	160 mm	7.5 mm	107.24.646
	224 mm	192 mm	9 mm	107.24.647
	290 mm	256 mm	9 mm	107.24.648
	353 mm	320 mm	9 mm	107.24.649

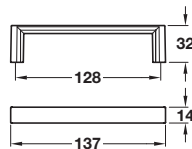

JUTLAND pull handle

- > Order M4 handle screws separately
- > Zinc alloy
- > Order qty: 1 pc



	Cat. No.
d chrome	107.03.235
Stainless steel effect	107.03.635

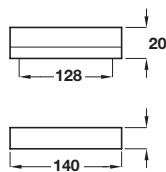

LUELLA pull handle

- > Order M4 handle screws separately
- > Aluminium
- > Order qty: 1 pc



	Cat. No.
Anodised	109.49.935



Don't forget to order M4 handle screws, see page **353**
 For our full range of fixing materials and installation tools see the Installation & Display section, pages **350-353**

Metropolis

The Metropolis range includes pull handles, bar handles and knobs in satin stainless steel

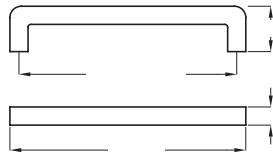

METROPOLIS pull handle

- > 2x M4 x 25 mm handle screws included
- > Grade 304 stainless steel



		ole centres	Cat. No.
Satin stainless steel	208 mm	192 mm	115.62.004
	336 mm	320 mm	115.62.008
	464 mm	448 mm	115.62.011

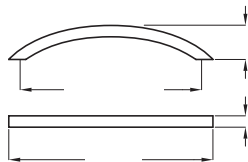

METROPOLIS bow handle

- > 2x M4 x 25 mm handle screws included



		ntres	Dim. A	Cat. No.
Satin stainless steel	181 mm	160 mm	31 mm	100.55.003
	259 mm	224 mm	32 mm	100.55.005
	365 mm	320 mm	33 mm	100.55.008

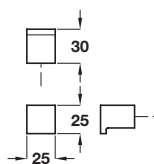

METROPOLIS knob

- > 1x M4 x 25 mm handle screw included
- > Grade 303 stainless steel
- > Order qty: 1 pc



	Size	Height	Cat. No.
Satin stainless steel	25 mm	30 mm	132.94.010

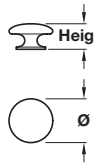

METROPOLIS knob

- > 1x M4 x 25 mm handle screw included
- > Grade 303 stainless steel
- > Order qty: 1 pc



	Diameter	Height	Cat. No.
Satin stainless steel	Ø 32 mm	30 mm	134.28.010
	Ø 38 mm	30 mm	132.94.040
	Ø 60 mm	35 mm	134.28.011

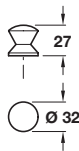

METROPOLIS knob

- > 1x M4 x 25 mm handle screw included
- > Grade 303 stainless steel
- > Order qty: 1 pc



	Diameter	Height	Cat. No.
Satin stainless steel	Ø 32 mm	27 mm	134.28.020

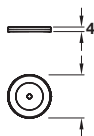
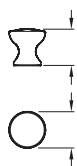

METROPOLIS knob and backplate

- > 1x M4 x 25 mm handle screw included
- > Grade 303 stainless steel
- > Order qty: 1 pc



	Item	Cat. No.
Satin stainless steel	Knob	132.94.030
	Backplate	132.94.090

+ Use with or without backplate. Order backplate separately

Plane

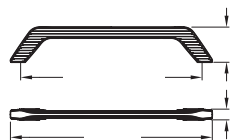
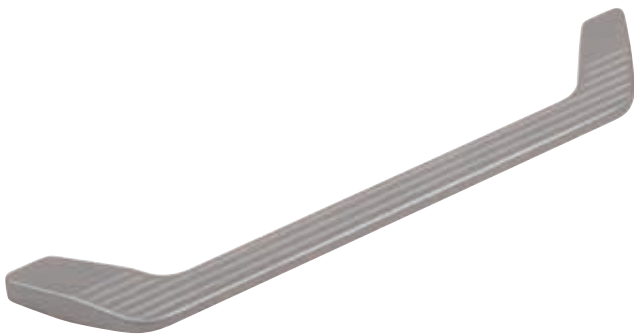

●					

➔ Don't forget to order M4 handle screws, see page **353**
 For our full range of fixing materials and installation tools see the Installation & Display section, pages **350-353**

Level



Dimensional data not binding. We reserve the right to alter specifications without notice.

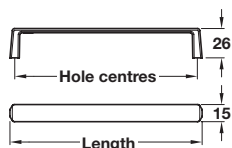

LEVEL pull handle

> Order M4 handle screws separately



		entres	Cat. No.
● Matt anthracite	72 mm	64 mm	111.71.505
	168 mm	160 mm	111.71.506
	328 mm	320 mm	111.71.507

Oasi

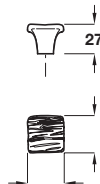
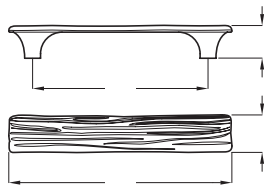

OASI bar handle

> Order M4 handle screws separately



	Cat. No.
 Polished chrome	116.60.213



> Zinc alloy
> Order qty: 1 pc



	Cat. No.
 Polished chrome	131.27.260

Jazz

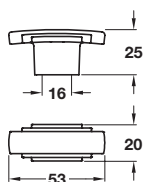

JAZZ pull handle

- > Order M4 handle screws separately
- > Zinc alloy
- > Order qty: 1 pc



	Cat. No.
 Polished chrome	112.92.240

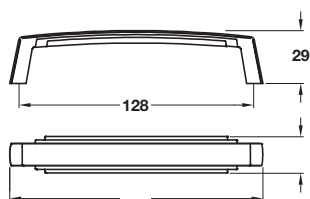

JAZZ pull handle

- > Order M4 handle screws separately
- > Zinc alloy
- > Order qty: 1 pc



	Cat. No.
 Polished chrome	112.92.245

Dimensional data not binding. We reserve the right to alter specifications without notice.



Don't forget to order M4 handle screws, see page **353**
 For our full range of fixing materials and installation tools see the Installation & Display section, pages **350-353**

Swing

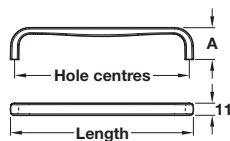

SWING D handle

> Order M4 handle screws separately



		ntres	Dim. A	Cat. No.
Matt brass	72 mm	64 mm	28 mm	111.71.500
	168 mm	160 mm	29 mm	111.71.501
	328 mm	320 mm	29 mm	111.71.502



Don't forget to order M4 handle screws, see page **353**

For our full range of fixing materials and installation tools see the Installation & Display section, pages **350-353**

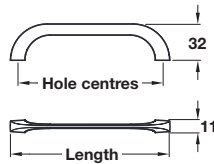

CEYLON pull handle

> 2x M4 x 25 mm and 2x M4 x 45 mm snap off



		e centres	Cat. No.
Brushed nickel	140 mm	128 mm	102.18.735
	332 mm	320 mm	102.18.738

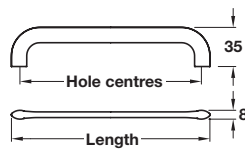

			Cat. No.
Matt black	79 mm	64 mm	111.71.010
	175 mm	160 mm	111.71.011
	335 mm	320 mm	111.71.012

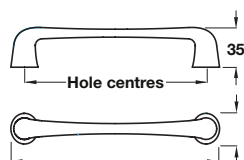

TONDA D handle

- > Order M4 handle screws separately
- > Zinc alloy
- > Order qty: 1 pc



	Length	Hole centres	Cat. No.
Polished nickel	184 mm	160 mm	110.22.290
	344 mm	320 mm	110.22.291

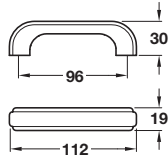

Product is subject to variations in colour and dimensions due to being manufactured from natural materials

ADDA D handle

- > Order M4 handle screws separately
- > Unfinished wood
- > Order qty: 1 pc



Type of wood	Cat. No.
 Oak	194.20.410

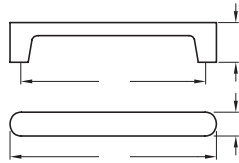

Product is subject to variations in colour and dimensions due to bei

CONTACT handle

- > Order M4 handle screws separately
- > Walnut, lacquered
- > Order qty: 1 pc



	Cat. No.
 Walnut	193.18.766

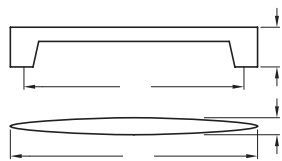

Product is subject to variations in colour and dimensions d

OVAL handle

- > Order M4 handle screws separately
- > Walnut, lacquered
- > Order qty: 1 pc



	Cat. No.
 Walnut	193.18.757



Don't forget to order M4 handle screws, see pages **21-23**

For our full range of fixing materials and installation tools see the Installation & Display section, pages **21-23**

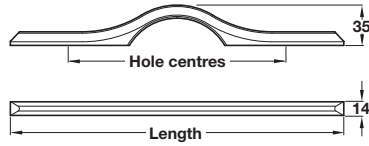

Product is subject to variations in colour and dimensions due to being manufactured from natural materials

EROS pull handle

- > Order M4 handle screws separately
- > Oak, lacquered
- > Order qty: 1 pc



		entres	Cat. No.
 Oak lacquered	294 mm	192 mm	193.18.420
	394 mm	256 mm	193.18.421
	594 mm	192/512 mm	193.18.423

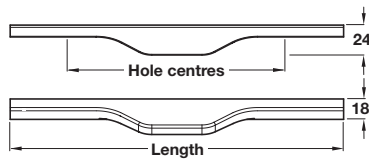

Product is subject to variations in colour and dimensions due to being manufactured from natural materials

ULTRA pull handle

- > Order M4 handle screws separately
- > Ash
- > Order qty: 1 pc



		Hole centres	Cat. No.
 Oak lacquered	294 mm	192 mm	193.18.417
	394 mm	256 mm	193.18.418
	594 mm	160/480 mm	193.18.419

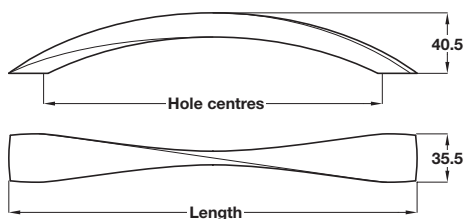

Product is subject to variations in colour and dimensions due to being manufactured from natural materials

TWIST pull handle

- > Order M4 handle screws separately
- > Oak
- > Order qty: 1 pc



		e centres	Cat. No.
 Oak unfinished	270 mm	224 mm	193.43.428
	388 mm	320 mm	193.43.429



Graf & Graf 2

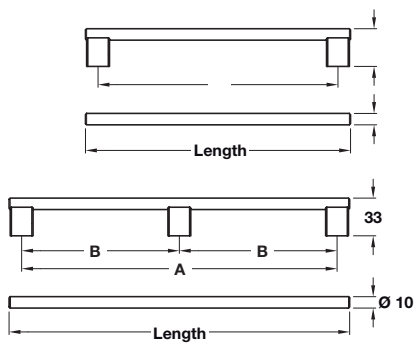



AF 2 bar handle

3x M4 x 25 mm handle screws included



ations without notice.



				
				
	182 mm	160 mm	-	132.19.120
Brushed dark brass	278 mm	256 mm	-	132.19.121
	1200 mm	1178 mm	589 mm	132.19.122

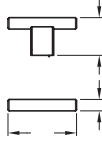

GRAF 2 T knob

- > 1x M4 x 25 mm handle screw included
- > Aluminium
- > Order qty: 1 pc



	Cat. No.
	132.19.105
	132.19.106
Brushed dark brass	132.19.107

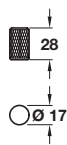

GRAF knob

- > 1x M4 x 25 mm handle screw included
- > Aluminium
- > Order qty: 1 pc



Finish	Cat. No.
Polished chrome	132.15.230
Brushed brass	132.19.210
Matt black	132.19.211
Stainless steel effect	132.15.630
Brushed dark brass	106.60.318

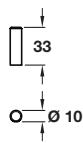

GRAF 2 cylindrical knob

- > 1x M4 x 25 mm handle screw included
- > Aluminium
- > Order qty: 1 pc



	Cat. No.
effect	132.19.100
	132.19.101
Brushed dark brass	132.19.102



Aspekt cabinet doors from - York matt midnight blue featured with Graf Big bar handles and knobs in dark brass finish

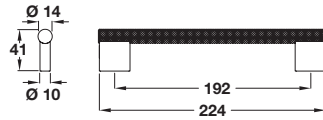

- > 2x M4 x 25 mm handle screws included
- > Aluminium
- > Order qty: 1 pc



	No.
	112
	.110
Brushed dark brass	106.66.111



GRAF BIG knob

- > 1x M4 x 25 mm handle screw included
- > Aluminium
- > Order qty: 1 pc



Finish	Ø 38 mm	Ø 50 mm
Stainless steel effect	106.66.102	106.66.105
shed black	106.66.100	106.66.103
Dark brass	106.66.101	106.66.104

View the full Aspekt cabinet doors range, visit www. .co.uk/aspekt-doors

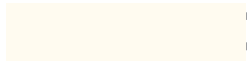

Flويد

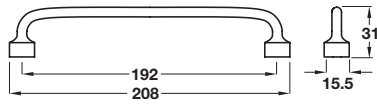

FLOID bar handle

- > 2x M4 x 25 mm handle screws included
- > Zinc alloy



Matt black	106.60.303



FLOID knob

- > 1x M4 x 25 mm handle screw included
- > Zinc alloy
- > Order qty: 1 pc



	Cat. No.
d gold	106.60.304
	106.60.305
brass	106.60.306
Matt black	106.60.307

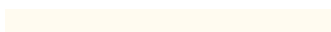
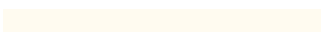

Firm

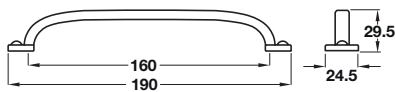

FIRM D handle

- > 2x M4 x 25 mm handle screws included
- > Zinc alloy
- > Order qty: 1 pc



Textured black

106.60.315



Tarvos, Encanto & Rhea

The Tarvos, Encanto and Rhea are textured furniture handles in a graphit Use to contrast or coordinate, the textured finish gives added style and m

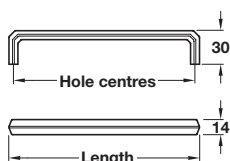

● Matt black	136 mm	128 mm	113.96.120
	168 mm	160 mm	113.96.121

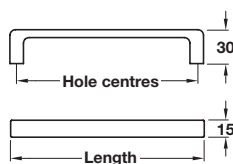

● Matt black	172 mm	160 mm	113.96.100
	332 mm	320 mm	113.96.101

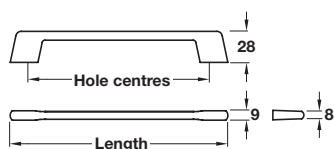

● Matt black	153 mm	128 mm	113.96.110
	185 mm	160 mm	113.96.111

U



Aspekt cabinet doors from - Hampstead ultragloss cashmere featured with U pull handles in matt black finish

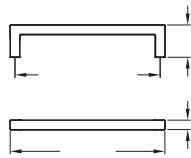

pull handle

2x M4 x 25 mm handle screws included
Zinc alloy
Order qty: 1 pc



			6.285
			6.388
			6.389
			6.390
			6.391
Brushed copper	136.5 mm	128 mm	108.66.376
	200.5 mm	192 mm	108.66.377
	328.5 mm	320 mm	108.66.378
	500.5 mm	492 mm	108.66.379

+ View the full Aspekt cabinet doors range, visit www.hampstead.co.uk/aspekt-doors

Este



Aspect cabinet doors from - Skye matt midnight blue featured with Este pull handles and Como knobs in brushed gold finish

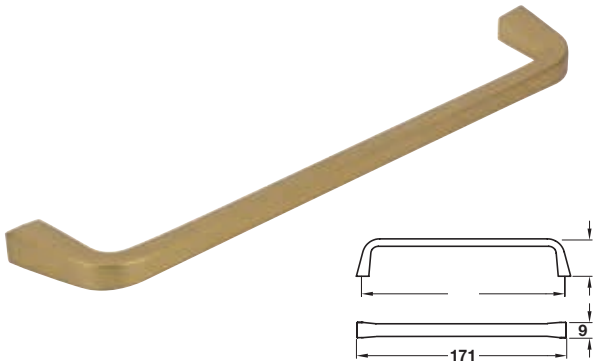

ESTE pull handle



Brushed copper

5

108.66.455

Dimensional data not binding. We reserve the right to alter specifications without notice.

➔ The COMO knob shown on page **173** matches the ESTE pull handle

➕ View the full Aspect cabinet doors range, visit www. .co.uk/aspect-doors

Olympia

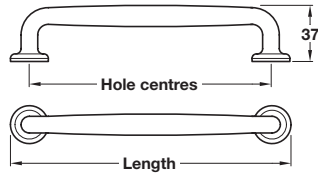

Note: ± 3 mm tolerance on non-critical dimensions and ± 1 mm on hole centre dimensions
Product is subject to variations in finish due to the finishing and manufacturing process of certain materials

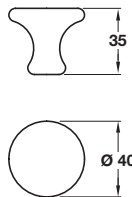

Note: ± 3 mm tolerance on non-critical dimensions
Product is subject to variations in finish due to the finishing and manufacturing process of certain materials

OLYMPIA pull handle

- > 2x M4 x 45 mm handle screws included
- > Pewter
- > Order qty: 1 pc



		Hole centres	Cat. No.
	185 mm	160 mm	120.89.909



OLYMPIA knob

- > 1x M4 x 45 mm handle screw included
- > Pewter
- > Order qty: 1 pc



	Cat. No.
	120.89.908



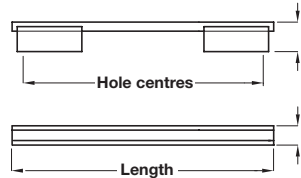
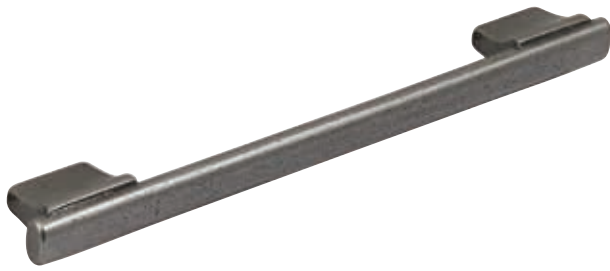

Product is subject to variations in finish due to the finishing and manufacturing process of certain materials

MAYFAIR pull handle

- > 2x M4 handle screws included
- > Cast iron



			Cat. No.
 Antique pewter	132 mm	96 mm	120.66.910
	164 mm	128 mm	120.66.902
	196 mm	160 mm	120.66.903
	228 mm	192 mm	120.66.904
	260 mm	224 mm	120.66.905

Dimensional data not binding. We reserve the right to alter specifications without notice.

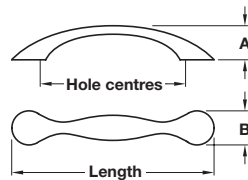

WARWICK bow handle

- > Order M4 handle screws separately
- > Zinc alloy
- > Order qty: 1 pc



		ntres	Dim. A	Dim. B	Cat. No.
 Antique pewter	137 mm	96 mm	28 mm	24.5 mm	110.93.902



Don't forget to order M4 handle screws, see page **353**
 For our full range of fixing materials and installation tools see the Installation & Display section, pages **350-353**

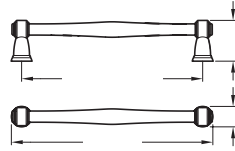

HERITAGE bar handle

- > 2x M4 x 25 mm handle screws included
- > Cast iron
- > Order qty: 1 pc



	th	Hole centres	Cat. No.
Natural iron	178 mm	160 mm	120.66.956

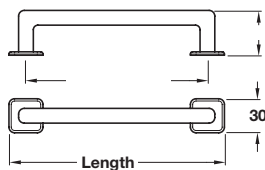

SALVADOR pull handle

- > 2x M4 x 45 mm M4 handle screws included
- > Pewter



	tres	Cat. No.	
Pewter	188 mm	160 mm	120.89.916

Note: ± 3 mm tolerance on non-critical dimensions and ±1 mm on hole centre dimensions
 Product is subject to variations in finish due to the finishing and manufacturing process of certain materials

Dimensional data not binding. We reserve the right to alter specifications without notice.

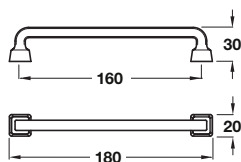
**BRERA D handle**

- > Order M4 handle screws separately
- > Zinc alloy

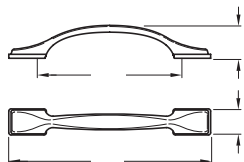

	.22.274
	.22.275
Pewter	110.22.276

Shapes

	Cat. No.
	110.22.277
Antique brass	110.22.278



- > Order M4 handle screws separately
- > Zinc alloy
- > Order qty: 1 pc



	Cat. No.
	110.22.279
Antique brass	110.22.280

Dimensional data not binding. We reserve the right to alter specifications without notice.

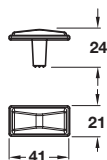

Don't forget to order M4 handle screws, see page **353**

For our full range of fixing materials and installation tools see the Installation & Display section, pages **350-353**



THEODORE D pull handle

- > Order M4 handle screws separately
- > Zinc alloy

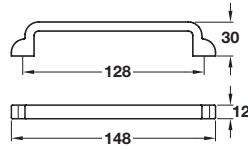

	Cat. No.
	106.61.143
	106.61.943
 Oil rubbed bronze	106.61.043



BESPOKE TIMBER DRAWERS

Kitchen drawers are becoming an increasingly popular alternative to traditional cabinets. Our drawer range and finishes, including a handcrafted



Walnut



Ply

Our Bespoke Timber Drawers are handmade in the UK from high grade solid timber. There are a number of design and personalisation choices available including a choice of wood types and come complete with dove-tailed joints.



Oak

Burbridge

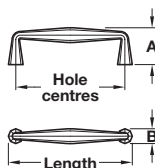

*Product is subject to variations in finish due to the finishing and manufacturing process of certain materials

BURBRIDGE pull handle

- > 2x M4 x 25 mm handle screws included
- > Brass or cast iron
- > Order qty: 1 pc



Fixings



		e _s	Dim. A	Dim. B	Cat. No.
		m	35 mm	15 mm	116.35.745
		m	37 mm	15 mm	116.35.746
		mm	35 mm	15 mm	116.35.545
		mm	35 mm	15 mm	116.35.945
	109 mm	96 mm	33 mm	13 mm	116.35.344
	212 mm	192 mm	40 mm	17 mm	116.35.347

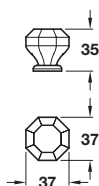

*Product is subject to variations in finish due to the finishing and manufacturing process of certain materials

BURBRIDGE knob

- > 1x M4 x 25 mm handle screw included
- > Brass
- > Order qty: 1 pc



Fixings included

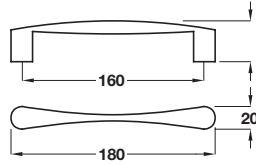

	Cat. No.
ss*	123.03.510
Polished nickel	123.03.710

**DEVON D handle**

> Order M4 handle screws separately

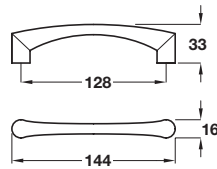

	at. No.
 Stainless steel effect	101.42.003

**EMERSON D handle**

> 2x M4 x 45 mm snap off handle screws included
> Zin
> Or



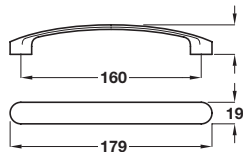

Finish	Cat. No.
 Matt nickel	101.71.022

**HARRINGTON D handle**

> 2x M4 x 45 mm snap off handle screws included
> Zinc alloy
> Order qty: 1 pc

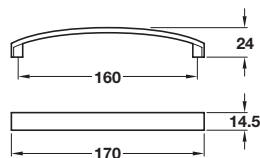

	Cat. No.
	111.85.223
 Stainless steel effect	111.85.023

**SAFFRON bow handle**

> Order M4 handle screws separately
> Aluminium



	Cat. No.
 Polished chrome	109.53.216

Caleido

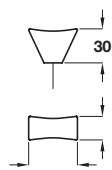
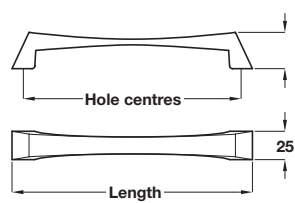

	214 mm	192 mm	32 mm	110.22.664
	342 mm	320 mm	34 mm	110.22.668
	150 mm	128 mm	31 mm	110.22.262
	214 mm	192 mm	32 mm	110.22.268
	342 mm	320 mm	34 mm	110.22.268

CALEIDO knob

- > 1x M4 x 25 mm handle screw included
- > Zinc alloy
- > Order qty: 1 pc



	Cat. No.
effect	131.10.620
Polished chrome	131.10.220

Dimensional data not binding. We reserve the right to alter specifications without notice.

AT A GLANCE

KITCHEN APPLICATIONS

BEDROOM APPLICATIONS

BATHROOM APPLICATIONS

HANDLE FREE APPLICATIONS

INSTALLATION & DISPLAY

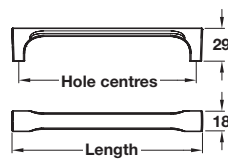

Colibri



COLIBRI pull handle

- > 2x M4 x 25 mm handle screws included
- > Zinc alloy
- > Order qty: 1 pc



		le centres	Cat. No.
		0 mm	111.62.226
		0 mm	111.62.229
	170 mm	160 mm	111.62.426
	330 mm	320 mm	111.62.429



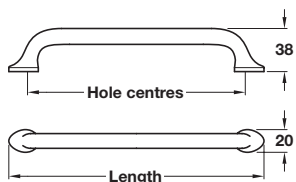

Note: ± 3 mm tolerance on non-critical dimensions and ±1 mm on hole centre dimensions

RIO pull handle



			at. No.
	192 mm	160 mm	119.29.706

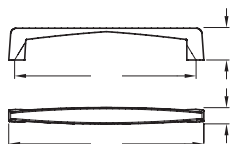

FALSTAFF pull handle

- > Order M4 handle screws separately
- > Zinc alloy



	Cat. No.
 Polished chrome	102.18.206

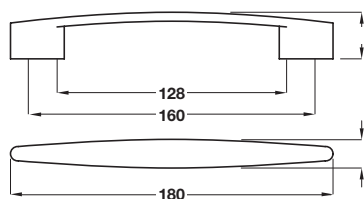

MONTROSE D pull handle

- > Order M4 handle screws separately
- > Zinc alloy
- > Order qty: 1 pc



	Cat. No.
 Polished chrome	110.34.236



Don't forget to order M4 handle screws, see page **353**
 For our full range of fixing materials and installation tools see the Installation & Display section, pages **350-353**

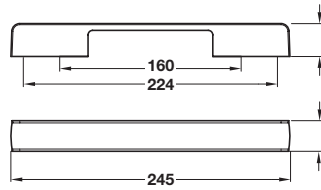

BLANCO D handle

- > Order M4 handle screws separately
- > Zinc alloy, with acrylic centres



	Cat. No.
Polished chrome with white insert	111.21.273

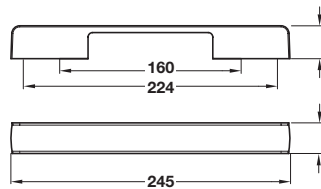

NOIR D handle

- > Order M4 handle screws separately



	at. No.
Polished chrome with black insert	111.21.233

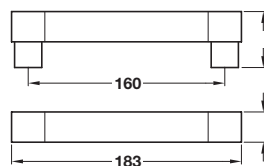

DOMINO bar handle

- > Order M4 handle screws separately
- > Zinc alloy, polished chrome with leather effect centre
- > Order qty: 1 pc



	Length	Hole centres	Cat. No.
	151 mm	128 mm	113.98.232
	183 mm	160 mm	113.98.233
	151 mm	128 mm	113.98.212
Brown	247 mm	224 mm	113.98.215



Don't forget to order M4 handle screws, see page **353**

For our full range of fixing materials and installation tools see the Installation & Display section, pages **350-353**

Crystal

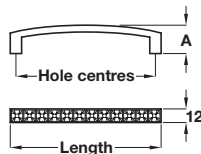

CRYSTAL D handle

- > Order M4 handle screws separately
- > Made with CRYSTALLIZED™ Swarovski Elements
- > Zinc alloy



				. No.
	107 mm	96 mm	22 mm	103.29.221
	140 mm	128 mm	25 mm	103.29.222

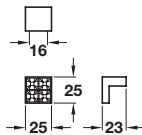

CRYSTAL pull handle

- > Order M4 handle screws separately
- > Made with CRYSTALLIZED™ Swarovski Elements
- > Zinc alloy
- > Order qty: 1 pc



	Cat. No.
Polished chrome	132.19.240

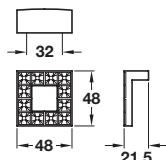

CRYSTAL pull handle

- > 2x M4 x 25 mm handle screws included
- > Made with CRYSTALLIZED™ Swarovski Elements
- > Zinc alloy
- > Order qty: 1 pc



	Cat. No.
Polished chrome	132.19.220

Glacio

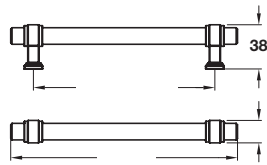

GLACIO pull handle

- > 2x 8/32 x 1" (non-metric) screws included
- > Zinc/Glass
- > Order qty: 1 pc



	Length	Hole centres	Cat. No.
	167 mm	128 mm	133.53.039
Polished nickel / Clear	200 mm	160 mm	133.53.040

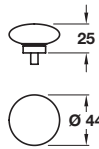

GLACIO knob

- > 1x 8/32 x 1" (non-metric) screw included
- > Zinc/Glass
- > Order qty: 1 pc



Finish	Cat. No.
 Polished nickel / Clear	133.50.122

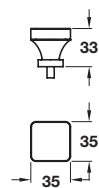

GLACIO square knob

- > 1x 8/32 x 1" (non-metric) screw included
- > Zinc/Glass
- > Order qty: 1 pc



Finish	Cat. No.
 Polished nickel / Clear	133.50.120



All handles on this page include 8/32 x 1" (non-metric) screw Cat. No. 022.24.881 shown on page **353**

re a different length order non-metric cut off

Byron

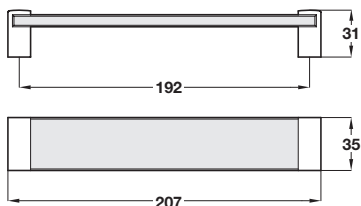

BYRON bar handle

- > 2x M4 x 25 mm handle screws included
- > Zinc alloy, with tempered glass



Polished chrome with clear glass	108.80.507
----------------------------------	------------

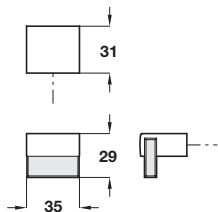

BYRON knob

- > 1x M4 x 25 mm handle screw included
- > Zinc alloy, with tempered glass
- > Order qty: 1 pc



Polished chrome with clear glass	Cat. No. 131.14.200
----------------------------------	------------------------

Glitter

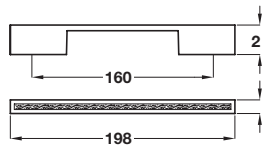

D handle

4 handle screws separately



Polished chrome with glitter inner, sealed

110.22.253

GLITTER knob

- > Order M4 handle screws separately
- > Zinc alloy
- > Order qty: 1 pc



Polished chrome with glitter inner, sealed

Cat. No.

132.15.220

GLITTER knob

- > Order M4 handle screws separately
- > Zinc alloy
- > Order qty: 1 pc



Polished chrome with glitter inner, sealed

Cat. No.

132.15.210

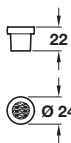
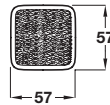
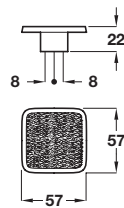

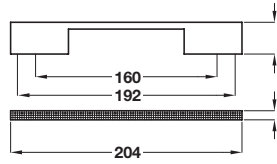

DISCO pull handle

- > Order M4 handle screws separately
- > Zinc alloy



	Cat. No.
 Polished chrome	110.22.243



BESPOKE TIMBER DRAWERS

Kitchen drawers are becoming an increasingly popular alternative to traditional cabinets. Our drawer range and finishes, including a handcrafted



Walnut



Ply



Oak

Our Bespoke Timber Drawers are handmade in the UK from high grade solid timber. There are a number of design and personalisation choices available including a choice of wood types and come complete with dove-tailed joints.

Dimensional data not binding. We reserve the right to alter specifications without notice.

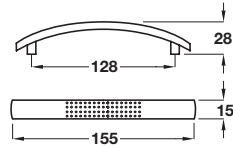

DOTTY lightweight bow handle

- > Order M4 handle screws separately
- > Zinc alloy
- > Order qty: 1 pc



	Cat. No.
 Polished chrome	101.69.262

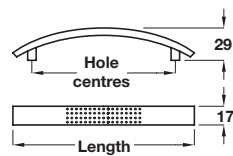

Dimple



DIMPLE bow handle

- > Order M4 handle screws separately
- > Zinc alloy



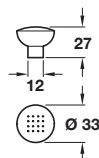

		Hole centres	Cat. No.
		96 mm	101.69.201
		128 mm	101.69.202
		96 mm	101.69.601
		128 mm	101.69.602
 Stainless steel effect	126 mm	96 mm	101.69.001
	158 mm	128 mm	101.69.002



DIMPLE knob

- > Order M4 handle screws separately
- > *1x M4 x 25 mm screw included
- > Zinc alloy



	Cat. No.
	135.48.202
	135.48.402
 Stainless steel effect	135.48.002*

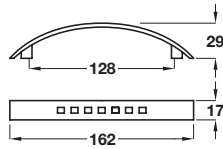

ANTROBUS bow handle

- > Order M4 handle screws separately
- > Zinc alloy



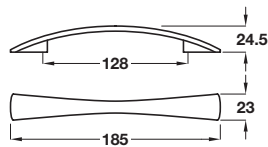

	Cat. No.
 Matt nickel plated	105.07.501



QUIGLEY bow handle

- > Order M4 handle screws separately
- > Zinc alloy



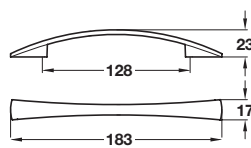

	Cat. No.
	109.29.202
	109.29.602
 Aluminium coloured	109.29.402



OCTAVIA lightweight bow handle

- > Order M4 handle screws separately
- > Zinc alloy
- > Order qty: 1 pc



	No.
	102.33.605
 Polished chrome	102.33.205



Don't forget to order M4 handle screws, see page **353**

For our full range of fixing materials and installation tools see the Installation & Display section, pages **350-353**

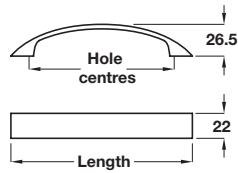

LEWIS bow handle

- > Order M4 handle screws separately
- > Zinc alloy
- > Order qty: 1 pc



	Length	Hole centres	Cat. No.
Stainless steel effect	160 mm	128 mm	107.72.602
	193 mm	160 mm	107.72.603

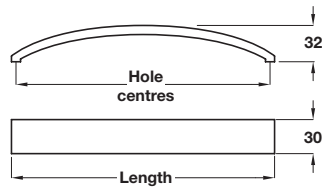

BELMONT bow handle

- > Order M4 handles screws separately
- > Aluminium



		entres	Cat. No.
Stainless steel effect	232 mm	224 mm	110.20.635
	335 mm	320 mm	110.20.638

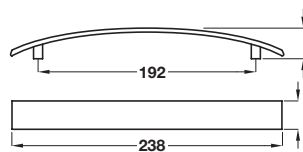

CICERO bow handle

- > Order M4 handle screws separately
- > Zinc alloy
- > Order qty: 1 pc



	Cat. No.
Stainless steel effect	102.35.034



Don't forget to order M4 handle screws, see page **353**

For our full range of fixing materials and installation tools see the Installation & Display section, pages **350-353**

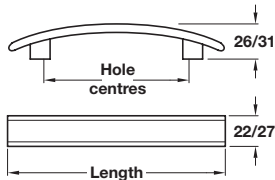

DARIA bow handle

- > 2x M4 x 45 mm snap off handle screws included
- > Zinc alloy, polished chrome/stainless steel effect finish
- > Order qty: 1 pc



	Length	Hole centres	Cat. No.
	144 mm	96 mm	102.34.251
	192 mm	128 mm	102.34.262

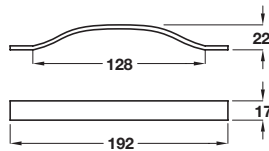

JACKSON bow handle

- > 2x M4 x 25 mm handle screws included
- > *2x M4 x 22 mm and 2 x M4 x 26 mm handle screws included
- > Zinc alloy



	Cat. No.
	106.75.203
Polished nickel	106.75.603*

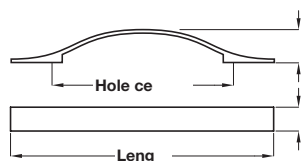

CHISWICK bow handle

- > Order M4 handle screws separately
- > Zinc alloy



			No.
			108.89.243
Stainless steel effect			108.89.043

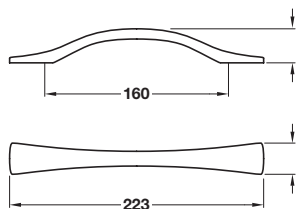

TARA bow handle

- > Order M4 handle screws separately
- > Zinc alloy



	o.
 Matt nickel	105.77.603

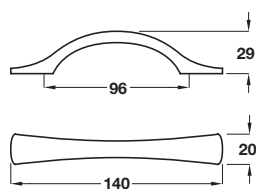

EMILY bow handle

- > Order M4 handle screws separately
- > Zinc alloy



	Cat. No.
 Matt nickel	104.38.601



SOPHIA pull handle

- > Order M4 handle screws separately
- > Zinc alloy

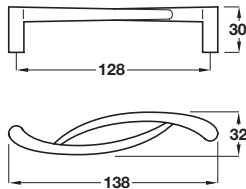



	Cat. No.
 Matt nickel	101.50.602

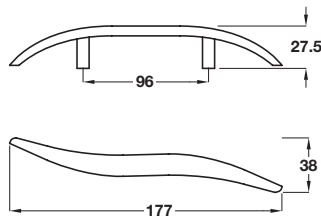

SILAS bar handle

- > Order M4 handle screws separately
- > Zinc alloy



	Cat. No.
 Polished chrome	103.36.600
 Matt nickel	103.36.201



Don't forget to order M4 handle screws, see page **353**
 For our full range of fixing materials and installation tools see the Installation & Display section, pages **350-353**

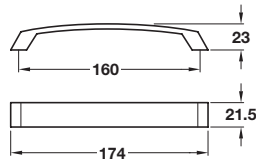

TAVISTOCK bow handle

- > 2 each of M4 x 22 mm and M4 x 25 mm handle screws included
- > *2x M4 x 45 mm snap off handle screws included
- > Aluminium



	No.
	226
Stainless steel effect	109.53.626*

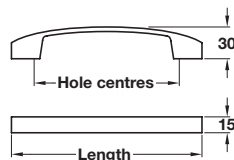

FLORENCE bow handle

- > Order M4 handle screws separately
- > Aluminium



		Hole centres	Cat. No.
Stainless steel effect	168 mm	128 mm	109.53.635
	200 mm	160 mm	109.53.636

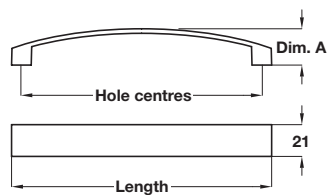

MELBURY bow handle

- > Order M4 handle screws separately
- > Zinc alloy



				t. No.
				113.82.015
				113.82.016
				113.82.019
Polished chrome	268 mm	256 mm	23 mm	113.82.219

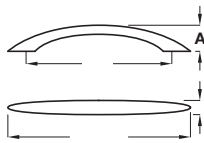

MANILIA bow handle

- > Order M4 handle screws separately
- > Zinc alloy
- > Order qty: 1 pc



			Dim. A	Dim. B	Cat. No.	
			23.5 mm	12 mm	105.65.601	
			23.5 mm	12.7 mm	103.78.603	
			29.5 mm	13.9 mm	101.08.600	
	Aluminium coloured	126 mm	96 mm	23.5 mm	12 mm	105.65.401

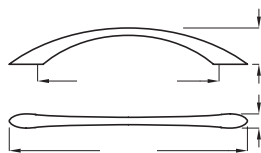

SABINE bow handle

- > Order M4 handle screws separately
- > Zinc alloy



					at. No.	
					103.84.604	
					105.16.605	
					101.07.600	
	Silver RAL 9006	154.9 mm	128 mm	28 mm	10.8 mm	103.84.214

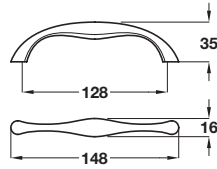

page **353**
 Installation tools see the Installation & Display section, pages **350-353**

**GRACE bow handle**

- > Order M4 handle screws separately
- > Zinc alloy
- > Order qty: 1 pc

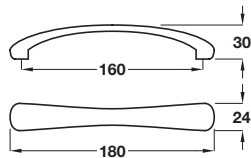

	Cat. No.
 Stainless steel effect	102.89.620

**AUBREY bow handle**

- > Order M4 handle screws separately
- > Zinc alloy
- > Order qty: 1 pc

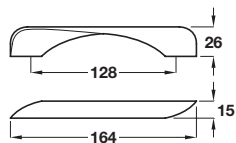

	Cat. No.
 Matt nickel	109.13.603

**REMUS bow handle**

- > 2x M4 x 25 mm handle screws included
- > Zinc alloy
- > Order qty: 1 pc



	Cat. No.
 Matt nickel	102.83.650



Don't forget to order M4 handle screws, see page **353**

For our full range of fixing materials and installation tools see the Installation & Display section, pages **350-353**

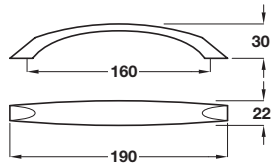

KAYLA bow handle

- > 2x M4 x 25 mm snap off handle screws included
- > Zinc alloy
- > Order qty: 1 pc



	Cat. No.
 Stainless steel effect	108.77.053

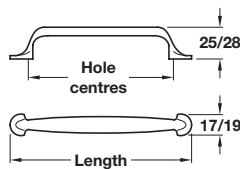

LOGAN D handle

- > 2x M4 x 45 mm snap off handle screws included
- > Zinc alloy



		Hole centres	Cat. No.
 Stainless steel effect	125 mm	96 mm	102.85.610
	162 mm	128 mm	102.85.620

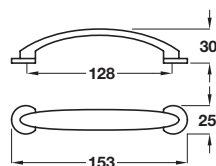

BRADLEY bow handle

- > Order M4 handle screws separately
- > Zinc alloy
- > Order qty: 1 pc



	Cat. No.
 Matt nickel	107.18.603

Arc

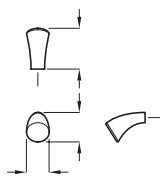
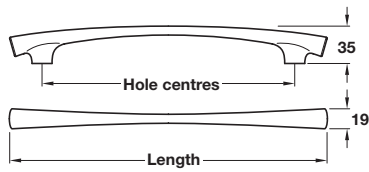

	185 mm	128 mm	111.62.212
Polished chrome	281 mm	224 mm	111.62.215



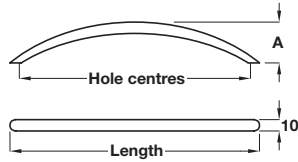

INDIGO bow handle

- > Order M4 handle screws separately
- > Steel
- > Order qty: 1 pc



		Hole centres	Dim. A	Cat. No.	
			30 mm	117.31.222	
		m	30 mm	117.31.231	
		m	32 mm	117.31.241	
		m	32 mm	117.31.261	
	Matt black	151 mm	128 mm	30 mm	106.43.302
		187 mm	160 mm	32 mm	106.43.303

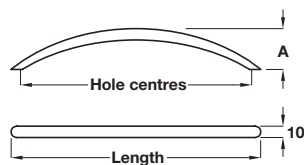

Bow handle

- > Order M4 handle screws separately



			im. A	Cat. No.	
			4 mm	106.43.401	
			0 mm	106.43.402	
			2 mm	106.43.403	
			0 mm	106.43.407	
	Polished brass	118 mm	96 mm	24 mm	106.43.801
		151 mm	128 mm	30 mm	106.43.802
		187 mm	160 mm	32 mm	106.43.803
		320 mm	288 mm	40 mm	106.43.807



Don't forget to order M4 handle screws, see page **353**
 For our full range of fixing materials and installation tools see the Installation & Display section, pages **350-353**

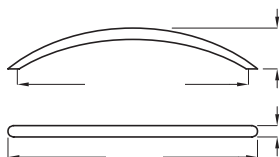

CEDAR bow handle

- > Order M4 handle screws separately
- > Steel
- > Order qty: 1 pc



		centres	Dim. A	Cat. No.
 Matt chrome	111 mm	96 mm	30 mm	117.31.421
	148 mm	128 mm	30 mm	117.31.431
	184 mm	160 mm	32 mm	117.31.441

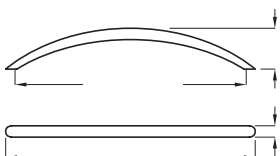

CLIFTON bow handle

- > Order M4 handle screws separately
- > *2x M4 handle screws included



			Dim. A	Cat. No.
 Brushed stainless steel effect	111 mm	96 mm	30 mm	117.31.021
	148 mm	128 mm	30 mm	117.31.031*
	184 mm	160 mm	32 mm	117.31.041
	221 mm	192 mm	32 mm	117.31.052
	258 mm	224 mm	32 mm	117.31.053
	332 mm	288 mm	32 mm	117.31.071



Don't forget to order M4 handle screws, see page **353**

For our full range of fixing materials and installation tools see the Installation & Display section, pages **350-353**

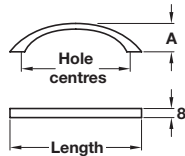

CORDELIA bow handle

- > Order M4 handle screws separately
- > Zinc alloy



		res	Dim. A	Cat. No.
Polished chrome	86.5 mm	64 mm	19 mm	107.66.210
	150 mm	128 mm	31 mm	107.66.212
	186 mm	160 mm	31.5 mm	107.66.213
	318 mm	288 mm	38.5 mm	107.66.217

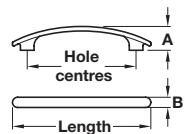

HUDSON bow handle

- > 2x M4 x 45 mm snap off screws included
- > Zinc alloy
- > Order qty: 1 pc



			Dim. A	Cat. No.
Polished chrome	90 mm	64 mm	19 mm	102.34.210
	123 mm	96 mm	21 mm	102.34.211
	157 mm	128 mm	22 mm	102.34.212
	190 mm	160 mm	24 mm	102.34.213
	256 mm	224 mm	27 mm	102.34.215
	320 mm	288 mm	33 mm	102.34.217

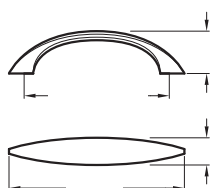

ELMER bow handle



- > 2x M4 x 25 mm handle screws included
- > *2x M4 x 45 mm snap off handle screws included
- > Zinc alloy
- > Order qty: 1 pc

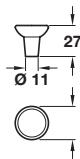
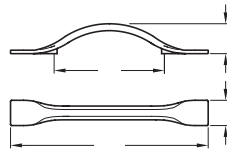

	h	Hole centres	Cat. No.
Stainless steel effect	118 mm	96 mm	102.03.601
	150 mm	128 mm	102.03.602*

Raviolo





	Cat. No.
	106.69.295
 Antique bronze	106.69.296

RAVIOLLO knob

- > 1x M4 x 25 mm handle screw included
- > Zinc alloy
- > Order qty: 1 pc



	Cat. No.
	106.69.300
 Antique bronze	106.69.301



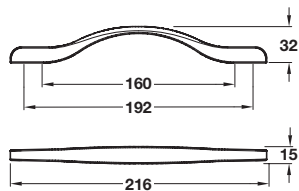



HENLEY bow handle

- > Order M4 handle screws separately
- > Zinc alloy
- > Order qty: 1 pc



	Cat. No.
	108.89.116
 Graphite	108.89.516



Don't forget to order M4 handle screws, see page **353**
 For our full range of fixing materials and installation tools see the Installation & Display section, pages **350-353**

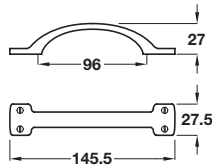

FABIAN bow handle

- > 2x M4 x 25 mm and 2x M4 x 45 mm handle screws included
- > Zinc alloy
- > Order qty: 1 pc



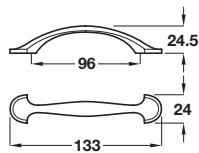

	Cat. No.
 Pewter	101.39.901



NORFOLK bow handle

- > Order M4 handle screws separately
- > Zinc alloy
- > Order qty: 1 pc



	Cat. No.
	101.85.102
 Antique pewter	101.85.902

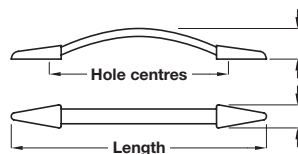

Product is subject to variations in finish due to the finishing and manufacturing process of

SHERWOOD bow handle

- > 2x M4 handle screws included
- > Cast iron



			Cat. No.
 Iron	192 mm	128 mm	120.67.902
	224 mm	160 mm	120.67.903



Don't forget to order M4 handle screws, see page **353**
For our full range of fixing materials and installation tools see the Installation & Display section, pages **350-353**



TAPER bow handle

> 2x M4 handle screws included

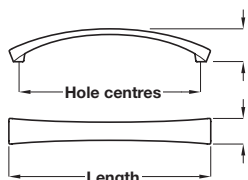

Product is subject to variations in finish due to the finishing and manufacturing process of cert



			t. No.
● Iron	181 mm	160 mm	120.64.013



BESPOKE TIMBER DRAWERS

Kitchen drawers are becoming an increasingly popular alternative to traditional cabinets. Our drawer rang and finishes, including a handcrafted



Our Bespoke Timber Drawers are handmade in the UK from high grade solid timber. There are a number of design and personalisation choices availabl including a choice of wood types and come complete with dove-tailed joints.



Dimensional data not binding. We reserve the right to alter specifications without notice.

Knightsbridge

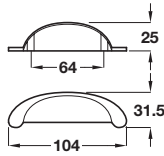

KNIGHTSBRIDGE cup handle

- > Order M4 handle screws separately
- > Zinc alloy
- > Order qty: 1 pc



	Cat. No.
 Stainless steel effect	118.55.620

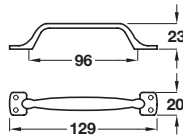

KNIGHTSBRIDGE D handle

- > Order M4 handle screws separately



	Cat. No.
 Stainless steel effect	118.69.620



Don't forget to order M4 handle screws, see page **353**

For our full range of fixing materials and installation tools see the Installation & Display section, pages **350-353**

Rochdale

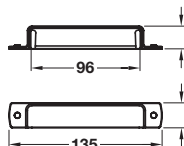

ROCHDALE cup handle

- > 2x 8/32 x 1" (non-metric) screws included
- > Zinc alloy
- > Order qty: 1 pc



	Cat. No.
 Satin nickel	133.50.142

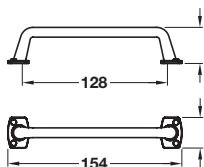

ROCHDALE pull handle



	o.
 Satin nickel	133.50.370

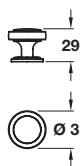

ROCHDALE knob

- > 1x 8/32 x 1" (non-metric) screw included
- > Zinc alloy
- > Order qty: 1 pc



	Cat. No.
 Satin nickel	133.50.632

Dimensional data not binding. We reserve the right to alter specifications without notice.



All handles on this page include 8/32 x 1" (non-metric) screws. If you require a different length order non-metric cut off screw Cat. No. 022.24.881 shown on page **353**

AT A GLANCE

KITCHEN APPLICATIONS

BEDROOM APPLICATIONS

BATHROOM APPLICATIONS

HANDLE FREE APPLICATIONS

INSTALLATION & DISPLAY

Henrietta

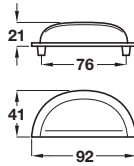

The MAYBERRY knob shown on page **133** also matches the HENRIETTA cup handle

HENRIETTA cup handle

- > 2x M4 x 25 mm and 2x M4 x 45 mm snap off handle screws included
- > *Order M4 handle screws separately
- > Zinc alloy
- > Order qty: 1 pc



	Cat. No.
	166.11.204*
	166.11.400*
Polished black nickel	166.11.305

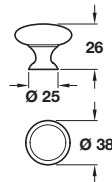

HENRIETTA knob

- > 1x M4 x 25 mm handle screw included
- > Zinc alloy
- > Order qty: 1 pc



Finish	Cat. No.
ed chrome	134.39.210
Stainless steel effect	134.39.020

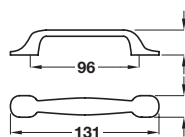

HENRIETTA D handle

- > 2x M4 x 25 mm handles screws and 2x M4 x 45 mm snap off handle screws included
- > *Order fixing screws separately
- > Aluminium



	Cat. No.
	109.48.224
Stainless steel effect	118.53.600*



Ariel

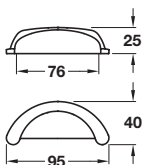

ARIEL cup handle

- > 2 each of M4 x 20 mm, 22 mm and 27 mm handle screws included
- > *Order fixing screws separately for polished chrome finish
- > Zinc alloy
- > Order qty: 1 pc



	Cat. No.
	166.11.240*
Pewter effect	166.11.905

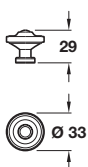

ARIEL knob

- > 1 each of M4 x 22 mm and 27 mm handle screws included
- > *Order fixing screws separately for polished chrome finish
- > Zinc alloy
- > Order qty: 1 pc



	Cat. No.
Polished chrome	134.06.200*
Pewter effect	166.11.900



Don't forget to order M4 handle screws, see page **353**
For our full range of fixing materials and installation tools see the Installation & Display section, pages **350-353**

Odessa

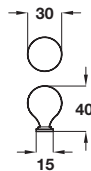
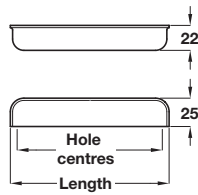

ODESSA cup handle

- > Order M4 handle screws separately
- > Zinc alloy
- > Order qty: 1 pc



	Length	Hole centres	Cat. No.
me	78 mm	64 mm	151.40.660
	140 mm	128 mm	151.40.665
effect	78 mm	64 mm	151.40.661
	140 mm	128 mm	151.40.666
Brushed copper	78 mm	64 mm	151.40.662
	140 mm	128 mm	151.40.667

ODESSA knob

- > Order M4 handle screws separately
- > Zinc alloy
- > Order qty: 1 pc



Finish	Cat. No.
Polished chrome	110.35.360
Stainless steel effect	110.35.361
Brushed copper	110.35.362



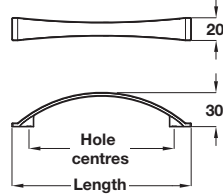



ODESSA bow handle

- > Order M4 handle screws separately
- > Zinc alloy
- > Order qty: 1 pc



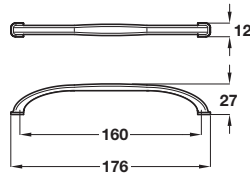
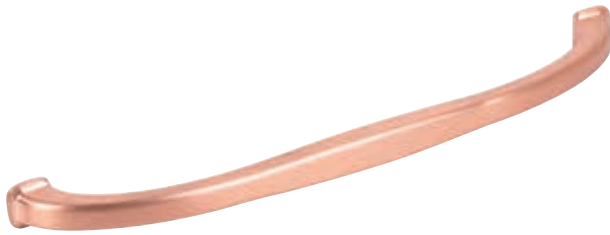

	Hole centres	Cat. No.
	128 mm	107.03.610
		107.03.611
 Brushed copper		107.03.613



ODESSA bow handle

- > Order M4 handle screws separately
- > Zinc alloy



	Cat. No.
	107.03.615
	107.03.616
 Brushed copper	107.03.617



Don't forget to order M4 handle screws, see page **353**
 For our full range of fixing materials and installation tools see the Installation & Display section, pages **350-353**

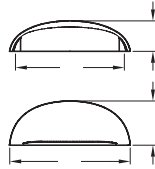

Note: ± 3 mm tolerance on non-critical dimensions

RESTORATION cup handle

> 2x M4 x 25 mm handle screws included



	Cat. No.
	151.00.200
Stainless steel effect	151.00.400

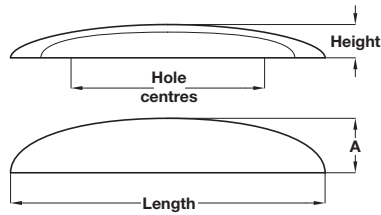

Product is subject to variations in colour and dimensions due to being manufactured from natural materials

WILTON cup handle

- > Order M4 handle screws separately
- > Oak unfinished
- > Order qty: 1 pc



	ngth	Hole centres	Height	Dim. A	Cat. No.
	80 mm	32 mm	20 mm	40 mm	192.52.421
Oak unfinished	210 mm	160 mm	22 mm	36.5 mm	192.52.425



Don't forget to order M4 handle screws, see page **353**

For our full range of fixing materials and installation tools see the Installation & Display section, pages **350-353**



Aspekt cabinet doors from [] - York matt dove grey and midnight blue featured with Mayberry cup handles and knobs in polished chrome finish

+ View the full Aspekt cabinet doors range, visit [www.\[\].co.uk/aspekt-doors](http://www.[].co.uk/aspekt-doors)

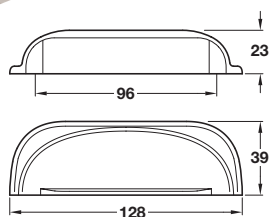

MAYBERRY cup handle

- > Order M4 handle screws separately
- > Zinc alloy
- > Order qty: 1 pc



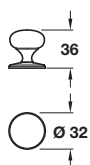

	Cat. No.
 Polished nickel	151.40.650



- > 1x M4 x 25 mm and 1x M4 x 45 mm snap off handle screws included
- > *Order M4 handle screws separately
- > Zinc alloy
- > Order qty: 1 pc



Finish	Cat. No.
 Polished nickel	123.02.130*
 Polished black nickel	123.02.330

+ The HENRIETTA cup handle shown on page 128 matches the MAYBERRY knob



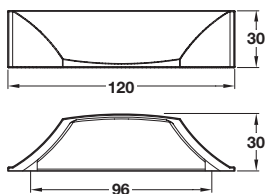

Augusta



AUGUSTA cup handle

- > Order M4 handle screws separately
- > Zinc alloy
- > Order qty: 1 pc



	Cat. No.
 effect	118.68.104
 Polished chrome	118.68.704
 Polished chrome	118.68.204
 Antique copper	118.68.804
 Antique copper	118.68.004

Dimensional data not binding. We reserve the right to alter specifications without notice.

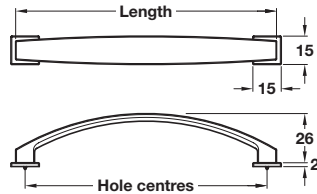

AUGUSTA bow handle with backplates

- > Order M4 handle screws separately
- > Use with or without backplates
- > Zinc alloy
- > Order qty: 1 set



		Hole centres	Cat. No.
		128 mm	103.30.105
		160 mm	103.30.106
		128 mm	103.30.705
		160 mm	103.30.706
		128 mm	103.30.205
		160 mm	103.30.206
		128 mm	103.30.805
		160 mm	103.30.806
	138 mm	128 mm	103.30.005
	170 mm	160 mm	103.30.006

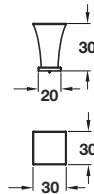
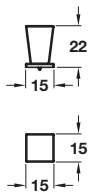

AUGUSTA knob with backplate

- > Order M4 handle screws separately
- > Use with or without backplate
- > Zinc alloy
- > Order qty: 1 set



Finish	15 x 15 mm	30 x 30 mm
s steel effect	110.35.380	110.35.392
nickel	110.35.381	-
chrome	110.35.382	110.35.390
ck	110.35.384	110.35.393
Antique copper	110.35.383	110.35.394



Don't forget to order M4 handle screws, see page **353**

For our full range of fixing materials and installation tools see the Installation & Display section, pages **350-353**

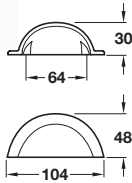

SMOOTH cup handle

- > 2x M4 x 25 mm handle screws and 2x M4 x 45 mm snap off screws included
- > Cast iron
- > Order qty: 1 pc



	Cat. No.
 Natural iron	120.67.951

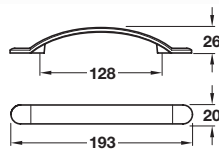

SMOOTH bow handle

- > 2x M4 x 25 mm handle screws and 2x M4 x 45 mm snap off screws included
- > Cast iron
- > Order qty: 1 pc



	Cat. No.
 Natural iron	120.67.963

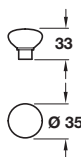

SMOOTH knob

- > 1x M4 handle screw included
- > Cast iron
- > Order qty: 1 pc



Finish	Cat. No.
 Natural iron	120.67.961

Beaulieu

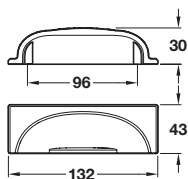

Note: ± 3 mm tolerance on non-critical dimensions and ±1 mm on hole centre dimensions
Product is subject to variations in finish due to the finishing and manufacturing process of certain materials

BEAULIEU cup handle

- > 2x M4 x 25 mm handle screws included
- > Cast iron
- > Order qty: 1 pc



	Cat. No.
 Natural iron	151.00.935

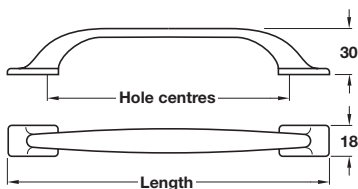

Note: ± 3 mm tolerance on non-critical dimensions and ±1 mm on hole centre dimensions
Product is subject to variations in finish due to the finishing and manufacturing process of certain materials

BEAULIEU D handle

- > 2x M4 x 25 mm handle screws included
- > Cast iron
- > Order qty: 1 pc



		Hole centres	Cat. No.
 Natural iron	169 mm	128 mm	119.29.055
	233 mm	192 mm	119.29.057

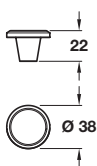

Note: ± 3 mm tolerance on non-critical dimensions
Product is subject to variations in finish due to the finishing and manufacturing process of certain materials

BEAULIEU knob

- > 1x M4 x 25 mm handle screw included
- > Cast iron
- > Order qty: 1 pc



	Cat. No.
 Natural iron	119.25.961

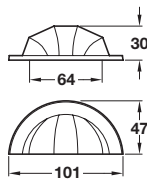

Note: ± 3 mm tolerance on non-critical dimensions and ±1 mm on hole centre dimensions
Product is subject to variations in finish due to the finishing and manufacturing process of certain materials

BOLD cup handle

- > 2x M4 x 25 mm handle screws included
- > Cast iron
- > Order qty: 1 pc



		Cat. No.
	Natural iron	123.02.020

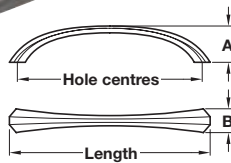

Note: ± 3 mm tolerance on non-critical dimensions and ±1 mm on hole centre dimensions
Product is subject to variations in finish due to the finishing and manufacturing process of certain materials

dle

m handle screws included



	Natural iron	141 mm	128 mm	28 mm	18 mm	123.02.002
	Natural iron	177 mm	160 mm	35 mm	21 mm	123.02.003

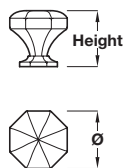

Note: ± 3 mm tolerance on non-critical dimensions
Product is subject to variations in finish due to the finishing and manufacturing process of certain materials

BOLD knob

- > 1x M4 x 25 mm handle screw included
- > Cast iron
- > Order qty: 1 pc



		Diameter	Height	Cat. No.
	Natural iron	Ø 38 mm	37 mm	123.02.060

Kane

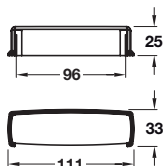

Product is subject to variations in finish due to the finishing and manufacturing process of certain materials

KANE cup handle

- > 2x 8/32 x 1" (non-metric) screws included
- > Zinc alloy
- > Order qty: 1 pc



	Cat. No.
 Oil rubbed bronze	133.50.140

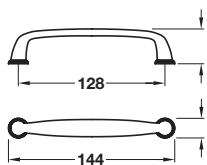

Product is subject to variations in finish due to the finishing and manufacturing process of certain m

KANE pull handle



	at. No.
 Oil rubbed bronze	133.50.340

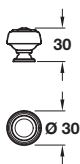

Product is subject to variations in finish due to the finishing and manufacturing process of certain materials

KANE knob

- > 1x 8/32 x 1" (non-metric) screw included
- > Zinc alloy
- > Order qty: 1 pc



Finish	Cat. No.
 Oil rubbed bronze	133.50.609



All handles on this page include 8/32 x 1" (non-metric) screws. If you require a different length order non-metric cut off screw Cat. No. 022.24.881 shown on page 353

Delia

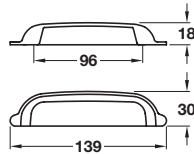

*Product is subject to variations in finish due to the finishing and manufacturing process of certain materials

DELIA cup handle

- > Order M4 handle screws separately
- > Brass
- > Order qty: 1 pc



	Cat. No.
	110.35.115
	110.35.116
Antique copper*	110.35.117

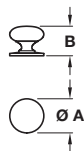

*Product is subject to variations in finish due to the finishing and manufacturing process of certain materials

DELIA knob

- > Order M4 handle screw separately
- > Brass
- > Order qty: 1 pc



Finish	Dim. A	Dim. B	Cat. No.
ss*	Ø 30 mm	26 mm	110.35.110
	Ø 35 mm	28 mm	110.35.105
Polished nickel	Ø 30 mm	26 mm	110.35.111
	Ø 35 mm	28 mm	110.35.106
Antique copper*	Ø 30 mm	26 mm	110.35.112
	Ø 35 mm	28 mm	110.35.107

Jude

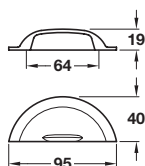



*Product is subject to variations in finish due to the finishing and manufacturing process of certain materials

JUDE cup handle

- > Order M4 handle screws separately
- > Brass
- > Order qty: 1 pc



	Cat. No.
 Brushed brass*	110.35.120
 Polished nickel	110.35.121
 Antique copper*	110.35.122

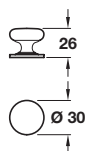



*Product is subject to variations in finish due to the finishing and manufacturing process of certain materials

JUDE knob

- > Order M4 handle screw separately
- > Brass
- > Order qty: 1 pc



Finish	Cat. No.
 Brushed brass*	110.35.100
 Polished nickel	110.35.101
 Antique copper*	110.35.102

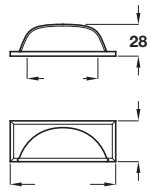

Note: ± 3 mm tolerance on non-critical dimensions and ± 1 mm
Product is subject to variations in finish due to the finishing and manufacturing

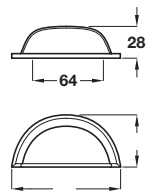

Note: ± 3 mm tolerance on non-critical dimensions and ± 1 mm
Product is subject to variations in finish due to the finishing and manufacturing p

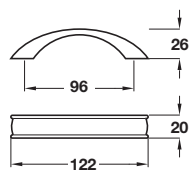

Note: ± 3 mm tolerance on non-critical dimensions and ± 1 mm on hole centre dimensions
Product is subject to variations in finish due to the finishing and manufacturing process of certain materials

LAMONT cup handle

- > 2x M4 x 45 mm snap off screws included
- > Pewter
- > Order qty: 1 pc



	ength	Hole centres	Cat. No.
Pewter	96 mm	64 mm	166.04.910
	167 mm	128 mm	166.04.912
	201 mm	160 mm	166.04.913



LAMONT cup handle

- > 2x M4 x 45 mm snap off screws include
- > Pewter
- > Order qty: 1 pc



	gth	Hole centres	Cat. No.
Pewter	98 mm	64 mm	166.04.920



LAMONT bow handle

- > 2x M4 x 45 mm handle screws included
- > Pewter



	e centres	Cat. No.
Pewter	122 mm	120.89.931



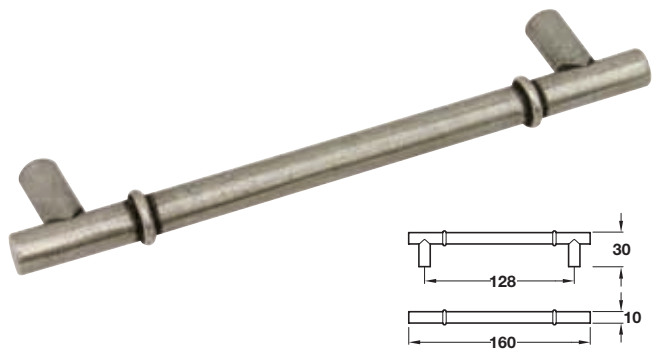

Note: ± 3 mm tolerance on non-critical dimensions and ±1 mm on hole centre dimensions
Product is subject to variations in finish due to the finishing and manufacturing process of certain materials



			Cat. No.
	160 mm	128 mm	120.89.912

LAMONT D handle, 2 ring design

- > 2x M4 x 25 mm handle screws included
- > Pewter

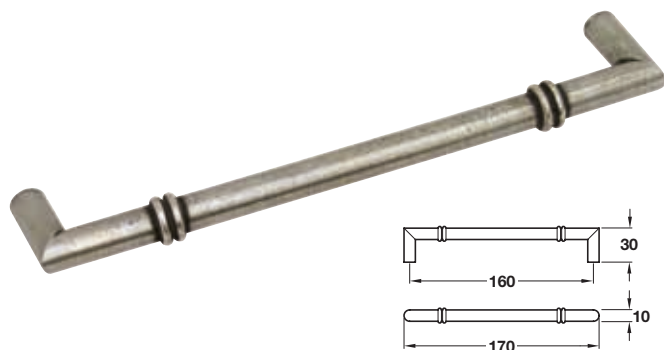

Note: ± 3 mm tolerance on non-critical dimensions and ±1 mm on hole centre dimensions
Product is subject to variations in finish due to the finishing and manufacturing process of certain materials



		es	Cat. No.
	170 mm	160 mm	120.89.913

LAMONT knob

- > 1x M4 x 45 mm handle screw included
- > Pewter
- > Order qty: 1 pc



Note: ± 3 mm tolerance on non-critical dimensions and ±1 mm on hole centre d
Product is subject to variations in finish due to the finishing and manufacturing process of certain



	Length	Hole centres	Cat. No.
	Ø 33 mm	20 mm	135.43.931
	Ø 43 mm	25 mm	135.43.932

LAMONT knob

- > 1x M4 x 45 mm snap off screw included
- > Pewter
- > Order qty: 1 pc



Note: ± 3 mm tolerance on non-critical dimensions and ±1 mm on hole centr
Product is subject to variations in finish due to the finishing and manufacturing process of cer



	Diameter	Height	Cat. No.
	Ø 36 mm	28 mm	135.43.960

Mulberry

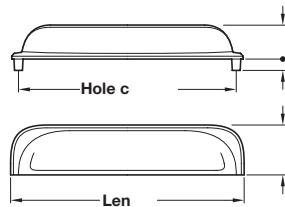

Note: ± 3 mm tolerance on non-critical dimensions and

MULBERRY cup handle

- > Order M4 handle screws separately
- > *2x M4 x 25 mm handle screws included
- > Brass
- > Order qty: 1 pc



		Hole centres	Cat. No.
Polished nickel	77 mm	64 mm	151.40.203*
	108 mm	96 mm	151.40.204*
	204 mm	192 mm	151.40.207*
chrome	108 mm	96 mm	151.40.254
Brushed copper	108 mm	96 mm	151.40.154



Dimensional data not binding. We reserve the right to alter specifications without notice.



Don't forget to order M4 handle screws, see page **353**

For our full range of fixing materials and installation tools see the Installation & Display section, pages **350-353**

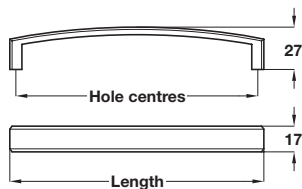

Note: ± 3 mm tolerance on non-critical dimensions and ±1 mm on hole centre dimensions

MULBERRY D handle

> 2x M4 x 25 mm handle screws included



		Hole centres	Cat. No.	
	Polished nickel	135 mm	128 mm	116.35.255
		168 mm	160 mm	116.35.256

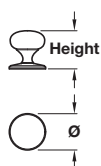

Note: ± 3 mm tolerance on non-critical dimensions

MULBERRY knob

> Order M4 handle screws separately
 > *1x M4 x 25 mm handle screw included
 > Brass
 > Order qty: 1 pc



	Diameter	Height	Cat. No.	
	nickel	Ø 32 mm	36 mm	123.02.700*
		Ø 38 mm	42 mm	123.02.710*
	chrome	Ø 38 mm	42 mm	134.97.220
	Brushed copper	Ø 38 mm	42 mm	134.97.020

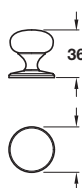

Note: ± 3 mm tolerance on non-critical dimensions and ±1 mm on hole centre d

MULBERRY knob

> 1x M4 x 25 mm handle screw included
 > Brass
 > Order qty: 1 pc



	Cat. No.
chrome	135.07.230
Stainless steel effect	135.07.600

Ironbridge

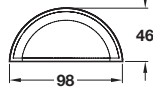
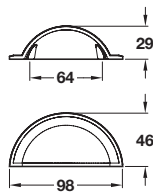

Note: ± 3 mm tolerance on non-critical dimensions and ± 1 mm on hole centre dimensions

IRONBRIDGE cup handle

- > 2x M4 x 25 mm handle screws included
- > Brass
- > Order qty: 1 pc



	Cat. No.
 Polished nickel	151.00.700

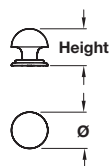

Note: ± 3 mm tolerance on non-critical dimensions and ± 1 mm on hole centre dimensions

IRONBRIDGE knob

- > 1x M4 x 30 mm handle screw included
- > Brass
- > Order qty: 1 pc



	meter	Height	Cat. No.
 Polished nickel	\varnothing 32 mm	34 mm	135.07.700
	\varnothing 38 mm	37 mm	135.07.710



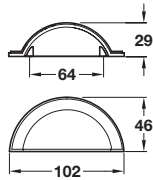

Note: ± 3 mm tolerance on non-critical dimensions and ±1 mm on hole centre dimensions
Product is subject to variations in finish due to the finishing and manufacturing process of certain materials

IRONBRIDGE cup handle

- > 2x M4 x 25 mm and 2x M4 x 45 mm snap off screws included
- > *2x M4 x 25 mm and 2x M4 x 30 mm handle screws included
- > Cast iron
- > Order qty: 1 pc



	Cat. No.
	151.00.924
 Aged brass effect	151.00.124*

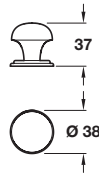

Note: ± 3 mm tolerance on non-critical dimensions and ±1 mm on hole centre dimensions
Product is subject to variations in finish due to the finishing and manufacturing process of certain materials

IRONBRIDGE knob

- > 1x M4 x 25 mm and 1x M4 x 45 mm handle screws included
- > *1x M4 x 30 mm handle screw included
- > Cast iron
- > Order qty: 1 pc



	Cat. No.
	119.25.950
 Aged brass effect	119.25.150*



The CONWY pull handle shown on page 148 matches the IRONBRIDGE cup handle and knob

Conwy

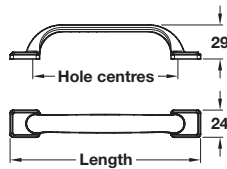

Note: ± 3 mm tolerance on non-critical dimensions and ± 1 mm on hole centre dimensions
Product is subject to variations in finish due to the finishing and manufacturing process of certain materials

CONWY pull handle

- > 2x M4 x 25 mm handle screws included
- > Base material



		centres	Cat. No.
		m	121.75.945
		m	121.75.956
	168 mm	128 mm	121.75.145

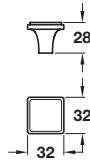

Note: ± 3 mm tolerance on non-critical dimensions and ± 1 mm on hole centre dimensions
Product is subject to variations in finish due to the finishing and manufacturing process of certain materials

CONWY knob

- > 1x M4 x 25 mm handle screw included
- > Cast iron
- > Order qty: 1 pc



	Cat. No.
Natural iron	119.25.940



The IRONBRIDGE cup handle and knob shown on page 147 matches the CONWY pull handle

Queslett

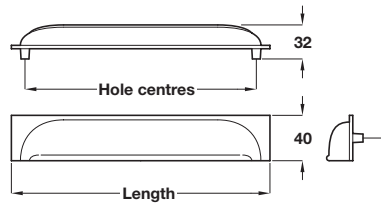

Note: ± 3 mm tolerance on non-critical dimensions and ± 1 mm on hole centre d

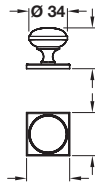

Note: ± 3 mm tolerance on non-c

QUESLETT cup handle

- > 2x M4 x 50 mm snap off handle screws included
- > Brass
- > Order qty: 1 pc



		ole centres	Cat. No.
Polished nickel	64 mm	40 mm	166.08.710
	108 mm	96 mm	166.08.711
	228 mm	202 mm	166.08.714

QUESLETT knob

- > 1x M4 x 50 mm snap off handle screw included
- > Brass
- > Order qty: 1 pc



	Cat. No.
Polished nickel	137.80.700



Aspekt cabinet doors from [] - Skye gloss ice white featured with Land cup pull handles and knobs in matt black finish

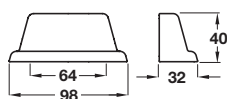

- > Zinc alloy
- > Order qty: 1 pc



	Cat. No.
	106.60.311
	106.60.312
s	106.60.313
Matt black	106.60.314

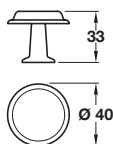

LAND knob

- > 1x M4 x 25 mm handle screw included
- > Zinc alloy
- > Order qty: 1 pc



Finish	Cat. No.
Brushed gold	106.60.308
Pewter	106.60.309
Antique brass	106.60.310
Matt black	106.60.321

Dimensional data not binding. We reserve the right to alter specifications without notice.

+ View the full Aspekt cabinet doors range, visit [www.\[\].co.uk/aspekt-doors](http://www.[].co.uk/aspekt-doors)

Crawford



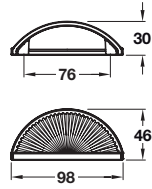

*Product is subject to variations in finish due to the finishing and manufacturing process of certain materials

CRAWFORD cup handle

- > 2x 8/32 x 1" (non-metric) screws included
- > Zinc alloy
- > Order qty: 1 pc



Finish	Cat. No.
Golden champagne	133.50.143
Oil rubbed bronze*	133.50.144

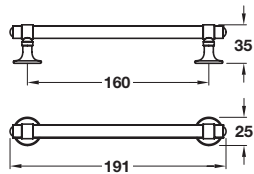
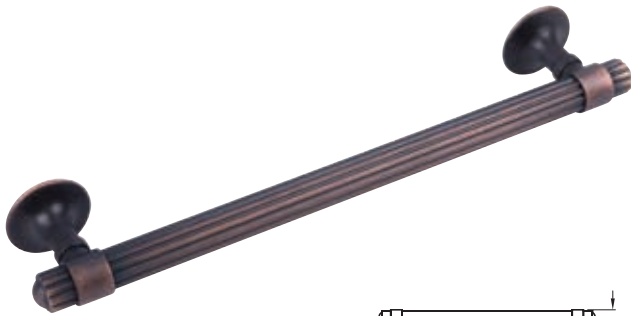

*Product is subject to variations in finish due to the finishing and manufacturing process of certain materials

CRAWFORD pull handle

- > 2x 8/32 x 1" (non-metric) screws included
- > Zinc alloy
- > Order qty: 1 pc



Finish	Cat. No.
Champagne	133.50.374
Oil rubbed bronze*	133.50.377

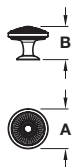

*Product is subject to variations in finish due to the finishing and manufacturing process of certain materials

ORD knob

- > 1x 8/32 x 1" (non-metric) screw included
- > Zinc alloy
- > Order qty: 1 pc



Finish	Dim. A	Dim. B	Cat. No.
Golden champagne	Ø 35 mm	30 mm	133.50.303
Oil rubbed bronze*	Ø 35 mm	30 mm	133.50.305



All handles on this page include 8/32 x 1" (non-metric) screws. If you require a different length order non-metric cut off screw Cat. No. 022.24.881 shown on page 353

Cotswold

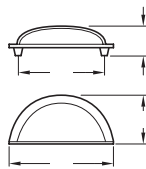

Note: ± 3 mm tolerance on non-critical dimensions and ±1 mm on hole centre dimensions
Product is subject to variations in finish due to the finishing and manufacturing process of certain materials

	151.07.001

Brushed copper

nob

- > 1x M4 x 50 mm handle screw included
- > Brass
- > Order qty: 1 pc

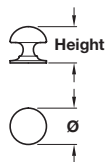

Note: ± 3 mm tolerance on non-critical dimensions and ±1 mm on hole centre dimensions
Product is subject to variations in finish due to the finishing and manufacturing process of certain materials

	Diameter	Height	Cat. No.
	Ø 31 mm	32 mm	134.97.710
	Ø 38 mm	39 mm	134.97.711
	Ø 38 mm	39 mm	134.97.011

Brushed copper



Brushed copper has not been lacquered and will change naturally over time

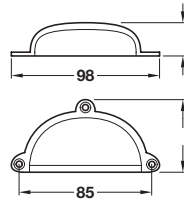

Note: ± 3 mm tolerance on non-critical dimensions and ±1 mm on hole ce

*Product is subject to variations in finish due to the finishing and manufacturing process of

COTSWOLD cup handle

- > 3x Ø 3.5 x 20 mm raised head screws included
- > Brass
- > Order qty: 1 pc



	Cat. No.
	166.08.700
	166.08.100
 Polished brass	166.08.800

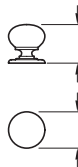

Note: ± 3 mm tolerance on non-critical dim

*Product is subject to variations in finish due to the finishing and manufacturing process of certain

COTSWOLD knob

- > 1x M4 x 50 mm snap off handle screw included
- > Brass
- > Order qty: 1 pc



	Diameter	Dim. A	Cat. No.
	Ø 31 mm	33 mm	133.32.710
	Ø 38 mm	36 mm	133.32.711
 ed*	Ø 33 mm	33 mm	133.32.100
 Polished brass	Ø 33 mm	33 mm	133.32.800

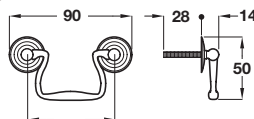

Note: ± 3 mm tolerance on

Product is subject to variations in finish due

COTSWOLD drop handle

- > 2x M4 spindle and nut included
- > Brass
- > Order qty: 1 pc



	Cat. No.
 Bronzed and brushed	120.13.130



Bronzed and brushed has not been lacquered and will change naturally over time

**EGG TIMER knob**

- > 1x M4 x 30 mm handle screw and 2x washers included
- > Aluminium
- > Order qty: 1 pc

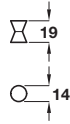

	Cat. No.
 Polished nickel	133.99.601

**BINX knob**

- > Order M4 handle screws separately
- > Steel
- > Order qty: 1 pc

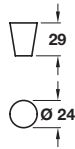

	Cat. No.
 Stainless steel effect	135.47.600

**LEO knob**

- > Order M4 handle screws separately
- > Zinc alloy
- > Order qty: 1 pc

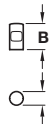

	Dim A	Dim B	Cat. No.
 Stainless steel effect	Ø 12 mm	23 mm	135.63.601
	Ø 20 mm	25 mm	135.63.602

**ORSON knob**

- > Order M4 handle screws separately
- > Aluminium
- > Order qty: 1 pc

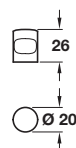

	Cat. No.
 Anodised aluminium	133.49.900



BEUVRON T knob

- > Order M4 handle screws separately
- > Zinc alloy
- > Order qty: 1 pc

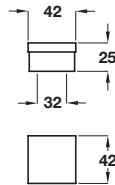

	Cat. No.
	108.55.000
Polished chrome	108.55.200



CORMOR pull handle

- > Order M4 handle screws separately
- > Zinc alloy
- > Order qty: 1 pc

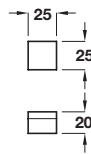

	Cat. No.
Stainless steel effect	131.17.000



DEXTER pull handle

- > Order M4 handle screws separately
- > Zinc alloy
- > Order qty: 1 pc

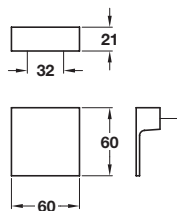

	Cat. No.
me	102.68.220
Stainless steel effect	102.68.020



Don't forget to order M4 handle screws, see page **353**
 For our full range of fixing materials and installation tools see the Installation & Display section, pages **350-353**

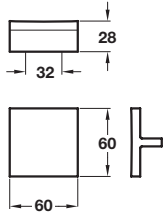

AMBER knob

- > Order M4 handle screws separately
- > Zinc alloy
- > Order qty: 1 pc



	Cat. No.
Polished chrome	131.14.260

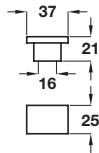

LARA knob

- > Order 2x M4 handle screws separately
- > Zinc alloy
- > Order qty: 1 pc



	Cat. No.
Polished chrome	131.17.200

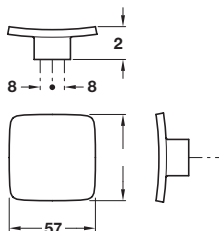
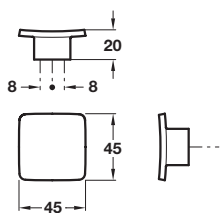

FLYNN knob

- > Order 2x M4 handle screws separately
- > Zinc alloy
- > Order qty: 1 pc



	45 x 45 mm	57 x 57 mm
Polished chrome	131.27.001	131.11.000
Polished chrome	131.27.201	131.11.200



OVAL knob

- > Order M4 handle screws separately
- > Zinc alloy
- > Order qty: 1 pc

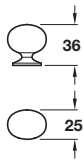



	Cat. No.
 Stainless steel effect	131.26.000

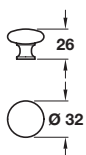

ORIEL knob

- > Order M4 handle screws separately
- > Zinc alloy
- > Order qty: 1 pc





	Cat. No.
 Stainless steel effect	134.02.600
 Stainless steel effect	135.24.600
 Polished chrome	133.09.200

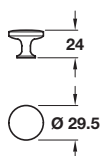

CASSIUS knob

- > Order M4 handle screws separately
- > Zinc alloy
- > Order qty: 1 pc



	Cat. No.
 Stainless steel effect	137.35.600

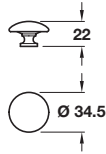

Don't forget to order M4 handle screws, see page **353**
 For our full range of fixing materials and installation tools see the Installation & Display section, pages **350-353**

**AMELIA knob**

- > 1x M4 x 25 mm handle screw included
- > *Order M4 handle screws separately
- > Zinc alloy
- > Order qty: 1 pc

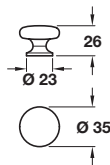

	Cat. No.
	135.00.600
	133.10.600*
 Polished chrome	133.10.200*

**ASPEN knob**

- > Order M4 handle screws separately
- > Zinc alloy
- > Order qty: 1 pc

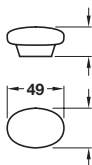

	Cat. No.
 Stainless steel effect	134.61.620

**BIANCA knob**

- > Order M4 handle screws separately
- > Zinc alloy
- > Order qty: 1 pc



	Cat. No.
 Stainless steel effect	133.96.602



Don't forget to order M4 handle screws, see page **353**

For our full range of fixing materials and installation tools see the Installation & Display section, pages **350-353**

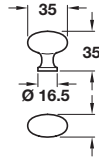

CLEO knob

- > Order M4 handle screws separately
- > Zinc alloy
- > Order qty: 1 pc



Finish	Cat. No.
 Stainless steel effect	134.63.620

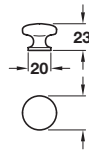

COCO knob

- > Order M4 handle screws separately
- > Zinc alloy
- > Order qty: 1 pc



Finish	Cat. No.
 Stainless steel effect	134.61.610

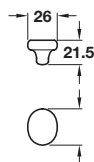

FLOYD knob

- > Order M4 handle screws separately
- > Zinc alloy
- > Order qty: 1 pc



Finish	Cat. No.
 Stainless steel effect	134.62.610

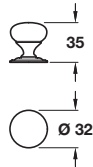



Note: ± 3 mm tolerance on non-critical dimensions

RUGBY knob

- > 1x M4 x 25 mm handle screw included
- > *1x M4 x 30 mm handle screw included
- > Brass
- > Order qty: 1 pc



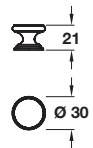

	Cat. No.
	134.97.701
 Stainless steel effect	134.97.001*



CLAYTON knob

- > Order M4 handle screws separately
- > Brass
- > Order qty: 1 pc



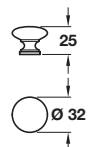

	Cat. No.
	137.71.803
 Polished chrome	137.71.205



CORRINE knob

- > Order M4 handle screws separately
- > Brass
- > Order qty: 1 pc



	Cat. No.
 Polished chrome	137.72.202
 Polished brass	137.72.800



Don't forget to order M4 handle screws, see page **353**



For our full range of fixing materials and installation tools see the Installation & Display section, pages **350-353**



GROSVENOR knob

- > Order M4 handle screws separately
- > Brass
- > Order qty: 1 pc



	Diameter	Dim. A	Cat. No.
	Ø 32 mm	28 mm	137.00.224
	Ø 38 mm	30 mm	137.00.205
 Polished brass	Ø 32 mm	28 mm	137.00.822
	Ø 38 mm	30 mm	137.00.805



BESPOKE TIMBER DRAWERS

Kitchen drawers are becoming an increasingly popular alternative to traditional cabinets. Our drawer range and finishes, including a handcrafted



Walnut



Ply



Oak

Rocher, Balley & Sula

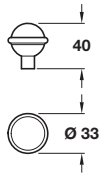

Note: ± 3 mm tolerance on non-critical dimensions

- > 1x M4 x 25 mm handle screw included
- > Brass
- > Order qty: 1 pc



	Cat. No.
 Polished nickel	137.80.730

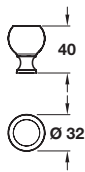

tolerance on non-critical dimensions

BALLEY knob

- > 1x M4 x 25 mm handle screw included
- > Brass
- > Order qty: 1 pc



	Cat. No.
 Polished nickel	135.07.720

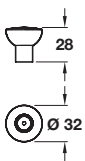

Note: ± 3 mm tolerance on non-critical dimensions

SULA knob

- > 1x M4 x 25 mm handle screw included
- > Brass
- > Order qty: 1 pc



	Cat. No.
 Polished nickel	135.07.730



Rocher knob Cat. No. 137.80.730 shown on round backplate Cat. No. 137.80.740

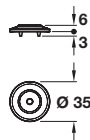

Note: ± 3 mm tolerance on non-critical dimensions

Round backplate

- > Order M4 handle screw separately
- > Brass
- > Order qty: 1 pc



	Cat. No.
 Polished nickel	137.80.740

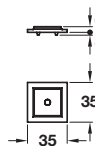

Note: ± 3 mm tolerance on non-critical dimensions

Square backplate

- > Order M4 handle screw separately
- > Brass
- > Order qty: 1 pc



	Cat. No.
 Polished nickel	137.80.750

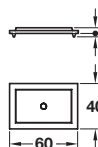

Note: ± 3 mm tolerance on non-critical dimensions

Rectangular backplate

- > Order M4 handle screw separately
- > Brass
- > Order qty: 1 pc



	Cat. No.
 Polished nickel	137.80.760

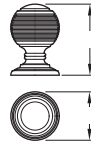

Note: ± 3 mm tolerance on non-critical dimensions and

JUPITER knob

- > 1x M4 x 25 mm handle screw included
- > Brass
- > Order qty: 1 pc



	Diameter	Height	Cat. No.
	Ø 32 mm	44 mm	123.02.080
Stainless steel effect	Ø 38 mm	52 mm	135.07.610

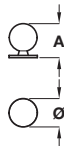

KENDRICK knob

- > Order M4 handle screws separately
- > Brass
- > Order qty: 1 pc



	Diameter	Dim. A	Cat. No.
	Ø 25 mm	30 mm	137.02.228
Polished chrome	Ø 30 mm	34 mm	137.02.237



Don't forget to order M4 handle screws, see page **353**

For our full range of fixing materials and installation tools see the Installation & Display section, pages **350-353**



VICTORIA knob

- > Order M4 handle screws separately
- > Ceramic
- > Order qty: 1 pc

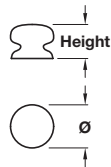

	Diameter	Dim. A	Cat. No.
	Ø 38 mm	30 mm	130.48.701
	Ø 38 mm	30 mm	130.48.407
	Ø 38 mm	30 mm	130.48.309
Black	Ø 50 mm	39 mm	130.48.302



CALVIN knob

- > Order M4 handle screws separately

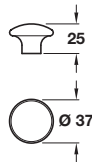

	Cat. No.
 White	130.19.710



IRIS knob

- > Order M4 handle screws separately
- > Ceramic
- > Order qty: 1 pc

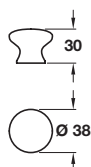

	Cat. No.
 White	130.17.700

Timber Grain Knobs

Timber knobs are available in two versions, routed cross grain and turned end grain. Routed knobs have the cross grain on top, like you have on a wooden front. Turned knobs have the end grain on top of the knob



Cross grain knobs -

Individually routed from a fixed wooden block with a full shaped tool. Each knob is then sanded to the final shape. This method of manufacture makes for a higher quality knob that shows the natural wood grain to it's best



End grain knobs -

Traditional turned knobs are turned on a copy lathe from a long turning wood dowel and cut off automatically. This method of manufacture is faster and produces a more economical and cost effective product



Oak, unfinished



Oak, antique oak stained and lacquered





Product is subject to variations in colour and dimensions due to being manufactured from natural materials

Knob, cross grain

- > Order M4 handle screws separately
- > Wood, unfinished or stained and lacquered
- > Order qty: 1 pc



	Diameter	Dim. A	Cat. No.
			195.63.400
	Ø 44 mm	40 mm	195.63.410

Oak, antique oak stained and lacquered



Oak, unfinished



Beech, unfinished





Product is subject to variations in colour and dimensions due to being manufactured from natural materials

Turned knob, end grain

- > Order M4 handle screws separately
- > Wood, unfinished
- > Order qty: 1 pc



	Diameter	Dim. A	Cat. No.
	Ø 34 mm	28 mm	195.75.401
	Ø 44 mm	38 mm	195.75.403
	Ø 34 mm	28 mm	195.75.301
Beech	Ø 44 mm	38 mm	195.75.302



Product is subject to variations in colour and dimensions due to being

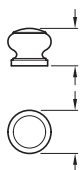

Turned knob, end grain

- > Order M4 handle screws separately
- > Wood, unfinished
- > Order qty: 1 pc



	Diameter	Dim. A	Cat. No.
	Ø 44 mm	38.5 mm	195.76.403
Oak	Ø 38 mm	33 mm	195.76.402



Product is subject to variations in colour and dimensions due to being manufacture

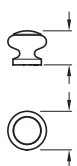

Turned knob, end grain

- > Order M4 handle screws separately
- > Wood, laquered
- > Order qty: 1 pc



	Diameter	Dim. A	Cat. No.
	Ø 34 mm	30 mm	195.68.400
Oak, clear lacquered			



Oak, unfinished



Oak, light oak stained and lacquered

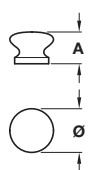



Product is subject to variations in colour and dimensions due to being manufactured from natural materials

Turned knob, end grain

- > Order M4 handle screws separately
- > Wood unfinished or stained and lacquered
- > Order qty: 1 pc



	Diameter	Dim. A	Cat. No.
	Ø 39 mm	28 mm	195.78.401
	Ø 44 mm	30 mm	195.78.402
	Ø 44 mm	40 mm	195.55.400
Oak, light oak stained and lacquered			



Don't forget to order M4 handle screws, see page **353**

For our full range of fixing materials and installation tools see the Installation & Display section, pages **350-353**



Oak, unfinished



Maple, unfinished



Beech, unfinished



Pine, unfinished

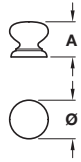

Product is subject to variations in colour and dimensions due to being manufactured from natural materials



Oak, unfinished



Oak, antique oak stained and lacquered

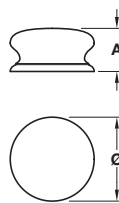

Product is subject to variations in colour and dimensions due to being manufactured from natural materials



Product is subject to variations in colour and dimensions due to being manufactured from natural materials

Turned knob, end grain

- > Order M4 handle screws separately
- > Wood, unfinished
- > Order qty: 1 pc



	Diameter	Dim. A	Cat. No.
	Ø 34 mm	31 mm	195.77.401
	Ø 44 mm	39 mm	195.77.402
	Ø 49 mm	40 mm	195.77.403
	Ø 44 mm	39 mm	195.77.102
	Ø 34 mm	31 mm	195.77.301
	Ø 44 mm	39 mm	195.77.302
	Ø 34 mm	31 mm	195.77.001

orian knob, cross grain

- > Order M4 handle screws separately
- > Wood, unfinished or stained and lacquered
- > Order qty: 1 pc



	Diameter	Dim. A	Cat. No.
	Ø 50 mm	37 mm	196.83.410
	Ø 54 mm	39 mm	195.64.400
	Ø 54 mm	39 mm	195.64.410

Shaker knob, cross grain

- > Order M4 handle screws separately
- > Wood unfinished
- > Order qty: 1 pc



	Diameter	Dim. A	Cat. No.
	Ø 45 mm	29 mm	195.60.300

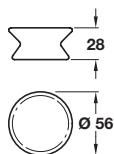



Product is subject to variations in colour and dimensions due to being manufactured from natural mater

knob

4 x 28 mm handle screws included
 r M4 handles screws separately
 de from FSC* certified wood
 or walnut
 > Order qty: 1 pc



Finish	Cat. No.
 Oak lacquered	195.79.430*
 Smoked oak	195.79.421**
 Walnut	195.79.740*

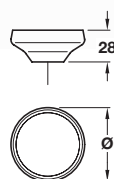



Product is subject to variations in colour and dimensions due to being manufactured from natural materials

ADOGAN knob

Order M4 handle screws separately
 Made from FSC certified wood
 Wood unfinished or lacquered
 Order qty: 1 pc



	Ø 42 mm	Ø 67 mm
 d	-	195.79.410
 Oak lacquered	195.79.423*	195.79.413*

SHAKER knob

> 1x M4 x 30 mm handle screw included
 > Oak
 > Order qty: 1 pc

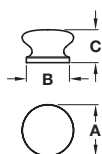

Product is subject to variations in colour and dimensions due to being manufactured from natural materials

Finish	Dim. A	Dim. B	Dim. C	Cat. No.
 Smoked oak	Ø 45 mm	Ø 38 mm	29 mm	195.60.410
	Ø 55 mm	Ø 48 mm	29 mm	195.62.410

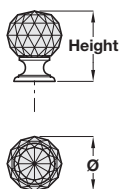

HARLEY knob

- > 1x M4 x 22 mm and 1x M4 x 25 mm handle screws included
- > Glass knob with brass base
- > Order qty: 1 pc



	gth	Height	Cat. No.
	Ø 30 mm	41 mm	139.60.422
	Ø 35 mm	45 mm	139.60.423

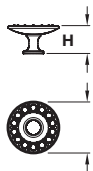

DIAMOND knob

- > Order M4 handle screws separately
- > Zinc alloy with Swarovski crystal
- > Order qty: 1 pc



	gth	Height	Cat. No.
	Ø 45 mm	27 mm	132.19.270

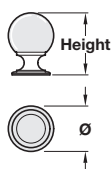

PRIMROSE knob

- > Order M4 handle screws separately
- > Zinc alloy with glass knob
- > Order qty: 1 pc



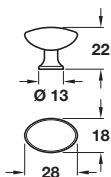

	Length	Height	Cat. No.
	Ø 25 mm	36 mm	139.60.400
	Ø 30 mm	41 mm	139.60.401



PEARL knob

- > Order M4 handle screws separately
- > Zinc alloy
- > Order qty: 1 pc



	Cat. No.
 ome	133.09.210
 el	133.09.410
 Brushed copper	133.09.010



Como



Aspekt cabinet doors from - Hampstead ultragloss aqua blue featured with Este pull handles and Como knobs in matt black finish

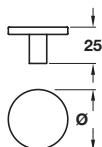

COMO knob

- > 1x M4 x 25 mm handle screw included
- > Zinc alloy
- > Order qty: 1 pc



	Cat. No.
	106.66.287
	106.66.285
	106.66.284
 Brushed copper	106.66.286



➔ The ESTE pull handle shown on page 91 matches the COMO knob

➕ View the full Aspekt cabinet doors range, visit www.ikea.co.uk/aspekt-doors

Dimensional data not binding. We reserve the right to alter specifications without notice.

AT A GLANCE

KITCHEN APPLICATIONS

BEDROOM APPLICATIONS

BATHROOM APPLICATIONS

HANDLE FREE APPLICATIONS

INSTALLATION & DISPLAY

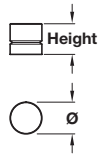

ACER knob

- > 1x M4 x 25 mm handle screw included
- > Stainless steel
- > Order qty: 1 pc



	Diameter	Height	Cat. No.
Stainless steel	Ø 18 mm	23 mm	134.88.611
	Ø 28 mm	27 mm	134.88.610

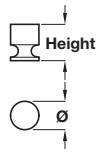

CYRUS knob

- > Order M4 handle screws separately
- > Brass
- > Order qty: 1 pc



	Diameter	Height	Cat. No.
Polished chrome	Ø 16 mm	20 mm	137.03.216
	Ø 19 mm	24 mm	137.03.225
	Ø 25 mm	32 mm	137.03.234

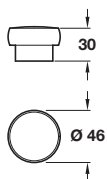

ACACIA knob

- > Order M4 handle screws separately
- > Zinc alloy
- > Order qty: 1 pc



	Cat. No.
Stainless steel effect	131.15.000



CHLOEU knob

- > Order M4 handle screws separately
- > Brass
- > Order qty: 1 pc

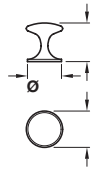

	Cat. No.
	123.03.500
	123.03.700

*Product is subject to variations in finish due to the finishing and manufacturing process of cer



KEW knob

- > 1x M4 x 25 mm handle screw included
- > Brass
- > Order qty: 1 pc

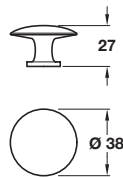

	Cat. No.
	134.97.482
	134.97.083

Note: ± 3 mm tolerance on non-critical dimensions



CONSTANCE knob

- > Order M4 handle screws separately
- > Zinc alloy
- > Order qty: 1 pc

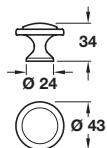

	Cat. No.
	134.45.220
	134.45.620



Don't forget to order M4 handle screws, see page **353**
For our full range of fixing materials and installation tools see the Installation & Display section, pages **350-353**

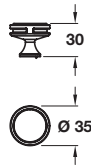

Oberon



OBERON knob

- > 1x 8/32 x 1" (non-metric) screw included
- > Zinc alloy
- > Order qty: 1 pc



	Cat. No.
 mpagne	133.50.618
 Polished nickel	133.50.622



All handles on this page include 8/32 x 1" (non-metric) screws. If you require a different length order non-metric cut off screw Cat. No. 022.24.881 shown on page **353**



CORBUSIER knob

- > 1x M4 handle screw included
- > Zinc alloy
- > Order qty: 1 pc

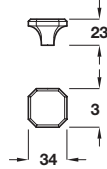

	Cat. No.
 Polished chrome	123.08.260

Luca



LUCA pull handle

- > Order M4 handle screws separately
- > Zinc alloy
- > Order qty: 1 pc

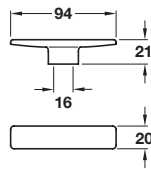



	Cat. No.
 Polished chrome	100.63.200

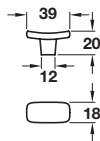

LUCA knob

- > Order M4 handle screws separately
- > Brass
- > Order qty: 1 pc



	Cat. No.
 Polished chrome	131.25.201

Dimensional data not binding. We reserve the right to alter specifications without notice.



Don't forget to order M4 handle screws, see page **353**
 For our full range of fixing materials and installation tools see the Installation & Display section, pages **350-353**

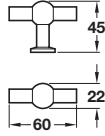

GEMINI pull handle

- > Order M4 handle screws separately
- > Zinc alloy
- > Order qty: 1 pc



	Cat. No.
 Stainless steel effect	137.55.600



ANGUS knob

- > Order M4 handle screws separately
- > Zinc alloy
- > Order qty: 1 pc



	Cat. No.
	118.06.214
	118.06.616
 Antique brass	118.06.116



Don't forget to order M4 handle screws, see page **353**

For our full range of fixing materials and installation tools see the Installation & Display section, pages **350-353**

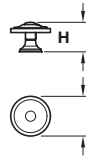
**ALBANO knob**

- > Order M4 handle screws separately
- > Zinc alloy
- > Order qty: 1 pc

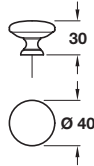

	Diameter	Height	Cat. No.
 Antique brass	Ø 30 mm	23 mm	134.33.111

**CARTON knob**

- > Order M4 handle screws separately
- > Brass
- > Order qty: 1 pc

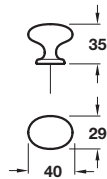

	Cat. No.
 Antique brass	122.49.110

**CHESTER knob**

- > Order M4 handle screws separately
- > Zinc alloy
- > Order qty: 1 pc



	Cat. No.
 Antique brass	120.70.160

**HELENE knob**

- > 1x M4 x 50 mm snap off handle screw included
- > Brass
- > Order qty: 1 pc



	Cat. No.
 Bronzed and brushed	133.31.100

Note: ± 3 mm tolerance on non-

Product is subject to variations in finish due to the finishing and manufacturing process



Bronzed and brushed has not been lacquered and will change naturally over time



Due to variations in dimensions during the manufacturing process of certain materials

POLKA knob

- > 1x M4 x 45 mm handle screw included
- > Cast iron
- > Order qty: 1 pc



Finish	Diameter	Dim. A	Cat. No.
 Natural iron	Ø 32 mm	29 mm	120.48.901

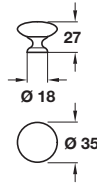

SORRENTO knob

- > Order M4 handle screws separately
- > Zinc alloy
- > Order qty: 1 pc



h	Cat. No.
 Antique pewter	133.97.913

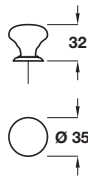

Note: ± 3 mm tolerance on non-critical dimensions

Product is subject to variations in finish due to the finishing and manufacturing process of certain materials

TAMAR knob

- > 1x M4 x 25 mm handle screw included
- > Cast iron
- > Order qty: 1 pc



Finish	Cat. No.
 Natural iron	121.75.920

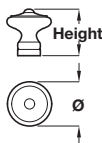

Note: ± 3 mm tolerance on non-critical dimension

Product is subject to variations in finish due to the finishing and manufacturing process of certain materials

TAURION knob

- > Order M4 handle screws separately
- > Cast iron
- > Order qty: 1 pc



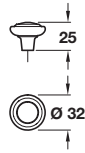

	Diameter	Height	Cat. No.
 Natural iron	Ø 30 mm	30 mm	119.25.902
	Ø 40 mm	40 mm	119.25.903

**EDEN knob**

- > Order M4 handle screws separately
- > Zinc alloy
- > Order qty: 1 pc

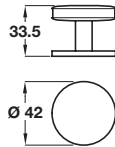

	Cat. No.
 Antique brass	134.27.186
 Antique pewter	134.27.980

**BRUNSWICK knob**

- > 1x M4 x 45 mm handle screw included
- > Pewter
- > Order qty: 1 pc



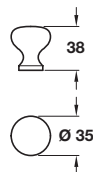

	Cat. No.
 Pewter	135.43.940

Note: ± 3 mm tolerance on non-critical dimensions and ±1 mm on hole centre dimensions
Product is subject to variations in finish due to the finishing and manufacturing process of certain materials

**BUXTON knob, Ø 35 mm**

- > 1x M4 x 25 mm handle screw included
- > Cast iron
- > Order qty: 1 pc



	Cat. No.
 Natural iron	119.27.004
 Black	119.12.300

Note: ± 3 mm tolerance on non-critical dimensions
Product is subject to variations in finish due to the finishing and manufacturing process of certain materials



Don't forget to order M4 handle screws, see page **353**

For our full range of fixing materials and installation tools see the Installation & Display section, pages **350-353**

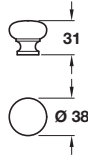

Note: ± 3 mm tolerance on non-critical dimensions
 Product is subject to variations in finish due to the finishing and manufacturing process of certain materials

SAVANNAH knob

- > 1x M4 x 25 mm handle screw included
- > Cast iron
- > Order qty: 1 pc



Finish	Cat. No.
 Natural iron	123.02.041

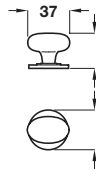

Note: ± 3 mm tolerance on non-critical dimensions
 Product is subject to variations in finish due to the finishing and manufacturing process

SYON knob

- > 1x M4 x 25 mm handle screw included
- > Cast iron
- > Order qty: 1 pc



Finish	Cat. No.
 Antique pewter	119.64.941

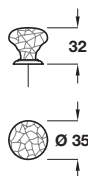



Note: ± 3 mm tolerance on non-critical dimensions
 Product is subject to variations in finish due to the finishing and manufacturing process of certain materials

ARCADIA knob

- > 1x M4 x 25 mm handle screw included
- > Cast iron and ceramic
- > Order qty: 1 pc



Finish	Cat. No.
 Antique silver / White crackled	121.75.930
 Antique brass / Bone	121.75.120

Twister



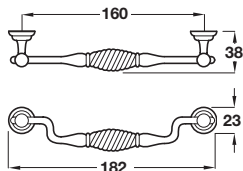

TWISTER drop handle

> 2x M4 x 26 mm handle screw included



Finish	Cat. No.
 Antique pewter	119.20.921

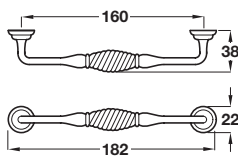

TWISTER D handle

> 2x M4 x 26 mm handle screw included
> Zinc alloy
> Order qty: 1 pc



Finish	Cat. No.
 Antique pewter	119.20.910

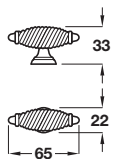

TWISTER pull handle

> 1x M4 x 26 mm handle screw included
> Zinc alloy
> Order qty: 1 pc



Finish	Cat. No.
 Antique pewter	119.20.900



TWISTER knob

> 1x M4 x 26 mm handle screw included
> Zinc alloy
> Order qty: 1 pc



Finish	Cat. No.
 Antique pewter	119.21.900

Caxton

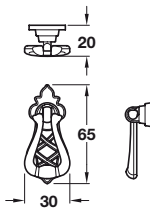

CAXTON drop handle

- > Order M4 handle screws separately
- > Zinc alloy
- > Order qty: 1 pc



Finish	Cat. No.
 Bronzed and brushed	122.37.100

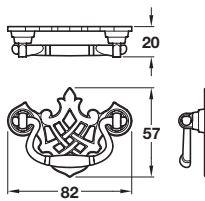

CAXTON drop bar handle

- > Order M4 handle screws separately
- > Zinc alloy
- > Order qty: 1 pc



Finish	Cat. No.
 Bronzed and brushed	122.38.100

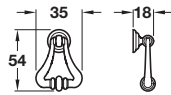

ARGENTON drop pendant handle

- > 1 M4 x 26 mm fixing screw included
- > Zinc alloy
- > Order qty: 1 pc



Finish	Cat. No.
 Antique brass	118.32.107

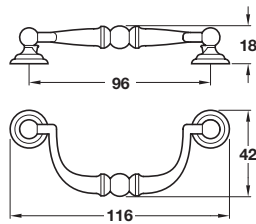

RISLE drop handle

- > Order M4 handle screws separately
- > Zinc alloy
- > Order qty: 1 pc



 Antique brass	118.10.101
--	------------



Don't forget to order M4 handle screws, see page **353**

For our full range of fixing materials and installation tools see the Installation & Display section, pages **350-353**

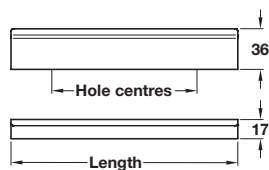
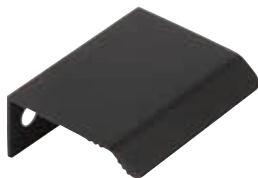

Curve



CURVE profile handle

- > 2x M4 x 25 mm handle screws included
- > Aluminium
- > Order qty: 1 pc



Finish	Length	Hole centres	Cat. No.
 Stainless steel effect	45 mm	32 mm	126.45.031
	100 mm	64 mm	126.45.032
	200 mm	128 mm	126.45.035
	300 mm	192 mm	126.45.037
	400 mm	320 mm	126.45.038
 Matt white	500 mm	416 mm	126.45.039
	45 mm	32 mm	126.45.751
 Matt black	200 mm	128 mm	126.45.755
	45 mm	32 mm	126.45.351
	200 mm	128 mm	126.45.355

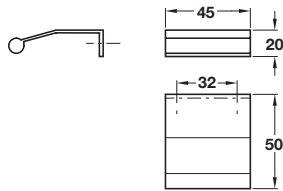

MADDOX pull handle

> Order M4 handle screws separately



	Cat. No.
	124.40.240
Matt chrome	124.40.440

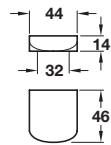
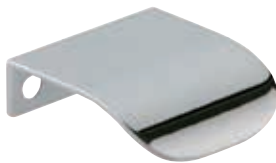

ELLA pull handle

> Order M4 handle screws separately
 > Zinc alloy
 > Order qty: 1 pc



	Cat. No.
Polished chrome	124.41.202
Matt chrome	124.41.402
Matt nickel	124.41.602

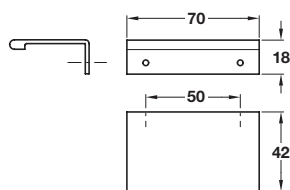
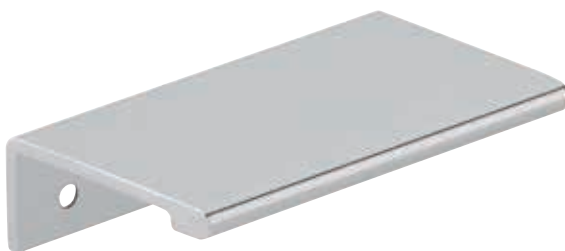

QUINN pull handle

> Order M4 handle screws separately



	Cat. No.
Polished chrome	124.02.220

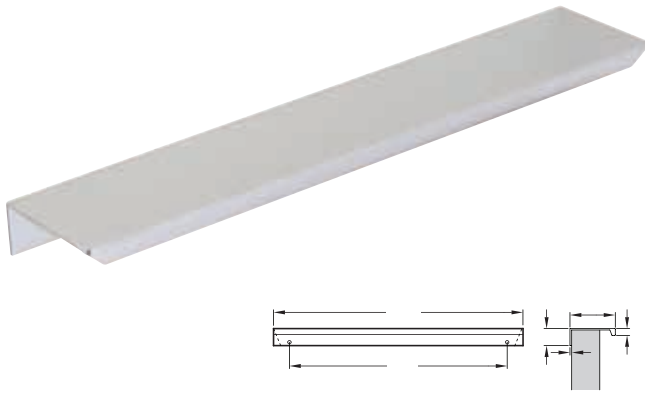

Don't forget to order M4 handle screws, see page **353**
 For our full range of fixing materials and installation tools see the Installation & Display section, pages **350-353**

**FINN trim handle**

- > 2x Ø 3.5 x 14 mm countersunk head screws included
- > Aluminium
- > Order qty: 1 pc

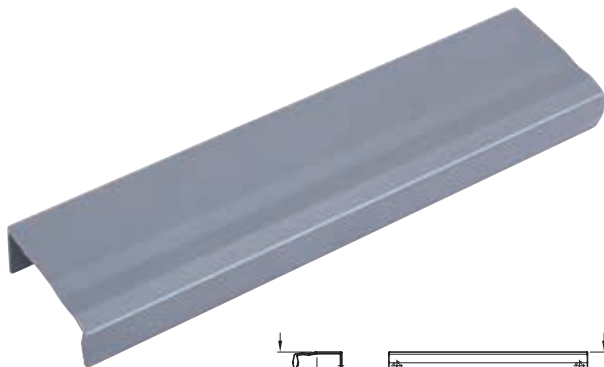

	Cat. No.
● Stainless steel effect	112.84.014

**LINE profile handle**

- > Order M4 handle screws separately
- > Aluminium
- > Order qty: 1 pc



	ength	Hole centres	Cat. No.
● Matt anthracite	78 mm	64 mm	111.71.510
	174 mm	160 mm	111.71.511
	334 mm	320 mm	111.71.512

**LISTER trim handle**

- > Order screws separately
- > Aluminium
- > Order qty: 1 pc



		ntres	Cat. No.
● Brushed nickel	147 mm	128 mm	126.17.641
	297 mm	256 mm	126.17.642

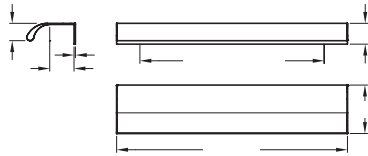

<input checked="" type="checkbox"/>				
<input type="checkbox"/>				
<input type="checkbox"/>				
<input type="checkbox"/>				
<input type="checkbox"/>				
<input type="checkbox"/>				
<input type="checkbox"/>				
<input type="checkbox"/>				



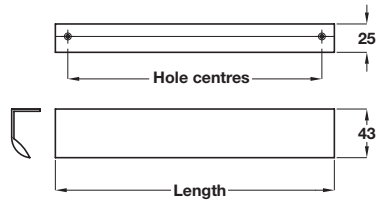

CALAVON trim handle

- > Order screws separately
- > Aluminium
- > Order qty: 1 pc



Finish			Cat. No.
Polished chrome	147 mm	128 mm	126.17.221
	297 mm	256 mm	126.17.222

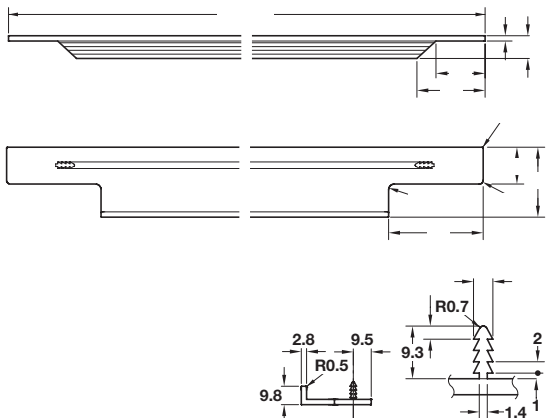

Note: ± 3 mm tolerance on non-critical dimensions

PORTOBELLO profile handle



		Cat. No.
Stainless steel effect	147 mm	126.45.010
	197 mm	126.45.011
	247 mm	126.45.012
	297 mm	126.45.013
	347 mm	126.45.014
	397 mm	126.45.015
	447 mm	126.45.016
	497 mm	126.45.017
	597 mm	126.45.018
	697 mm	126.45.019
	797 mm	126.45.020
	897 mm	126.45.021
997 mm	126.45.022	
1197 mm	126.45.023	

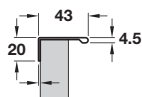

SAANE profile grip, cabinet-wide handle

- > Aluminium silver
- > Order qty: 1 pc

	Length	Cat. No.
Silver	2500 mm	126.14.901

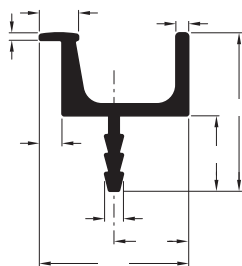
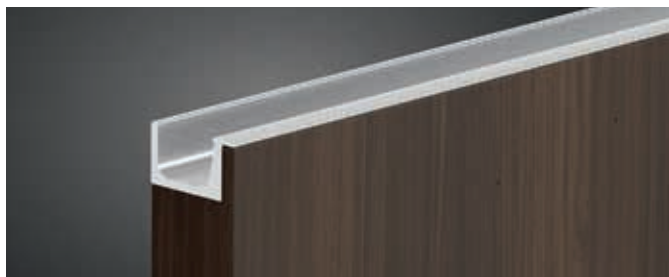

file handle

uminium
pc

	Length	Groove length	Cat. No.
 Stainless steel effect	2500 mm	2450 mm	126.95.000

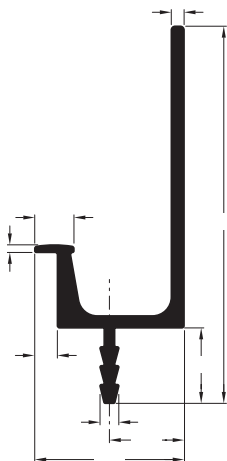

handle

uminium
pc

	Length	Groove length	Cat. No.
 Stainless steel effect	2500 mm	2450 mm	126.95.010

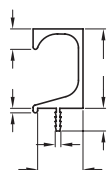

e handle

uminium
pc

	Length	Cat. No.
 Silver anodised aluminium	2500 mm	155.01.150

Dimensional data not binding. We reserve the

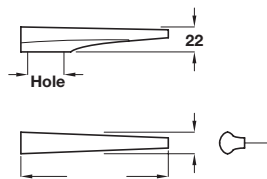

Fixings included

	Length	Hole centres	Cat. No.
Polished chrome	130 mm	32 mm	107.03.200
	210 mm	32/64 mm	107.03.201
	280 mm	64/96 mm	107.03.202

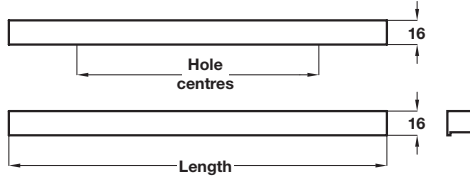

AVELINE pull handle

- > 2x M4 x 25 mm handle screws included
- > Aluminium
- > Order qty: 1 pc



		ole centres	Cat. No.
 Polished chrome	80 mm	32 mm	110.46.911
	250 mm	160 mm	110.46.916
	350 mm	224 mm	110.46.917
	550 mm	480 mm	110.46.918

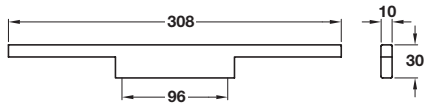

ELVO pull handle

- > Order M4 handle screws separately
- > Zinc alloy
- > Order qty: 1 pc



	Cat. No.
 Polished chrome	112.90.251



page **353**
 Installation tools see the Installation & Display section, pages **350-353**

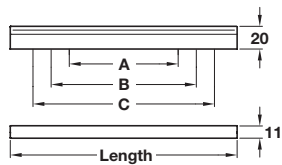

Angle



ANGLE pull handle

- > 2x M4 x 25 mm handle screws included
- > Aluminium
- > Order qty: 1 pc



					Cat. No.
					108.66.230
					108.66.231
					108.66.232
					108.66.234
					108.66.330
 Stainless steel effect	200 mm	96 mm	128 mm	160 mm	108.66.030

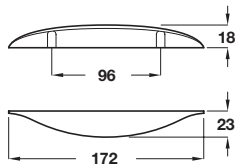
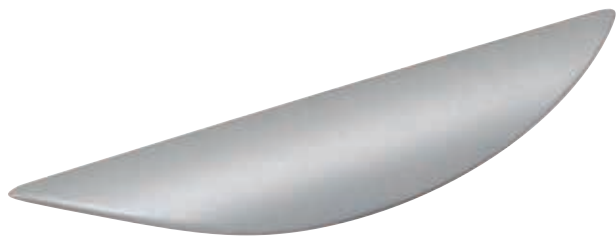

AZALEA pull handle

- > Order M4 handle screws separately
- > Zinc alloy
- > Order qty: 1 pc



	Cat. No.
	106.33.602
 Silver RAL 9006	106.33.902

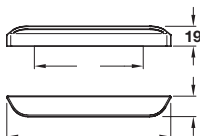

OXFORD pull handle

- > 2x M4 x 25 mm handle screws and 2x M4 x 45 mm snap off handle screws included
- > Zinc alloy
- > Order qty: 1 pc



	Cat. No.
 Polished chrome	102.18.224



page **353**
Installation tools see the Installation & Display section, pages **350-353**

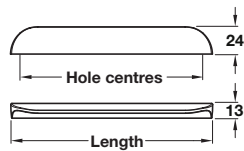

Nick



NICK pull handle

- > 2x M4 x 25 mm handle screws included
- > Aluminium
- > Order qty: 1 pc



	Length	Hole centres	Cat. No.
	50 mm	32 mm	126.45.060
	178 mm	160 mm	126.45.061
	50 mm	32 mm	126.45.062
	178 mm	160 mm	126.45.063





Noma

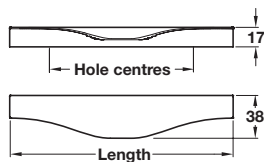

NOMA profile handle

- > 2x M4 x 15 mm handle screws included
- > Aluminium
- > Order qty: 1 pc



	gth	Hole centres	Cat. No.
	mm	128 mm	126.45.045
	mm	256 mm	126.45.048
	200 mm	128 mm	126.45.965
	350 mm	256 mm	126.45.969
	200 mm	128 mm	126.45.046
	350 mm	256 mm	126.45.049

Dimensional data not binding. We reserve the right to alter specifications without notice.



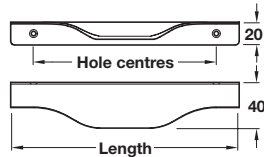

PATIENCE profile handle

- > Order M4 handle screws separately
- > Aluminium
- > Order qty: 1 pc



	length	Hole centres	Cat. No.
● Brushed copper	200 mm	160 mm	126.17.230
	300 mm	256 mm	126.17.231
	400 mm	320 mm	126.17.232



BESPOKE TIMBER DRAWERS

Kitchen drawers are becoming an increasingly popular alternative to traditional cabinets. Our drawer rang and finishes, including a handcrafted



Walnut



Ply

Our Bespoke Timber Drawers are handmade in the UK from high grade solid timber. There are a number of design and personalisation choices availa including a choice of wood types and come complete with dove-tailed joints.



Oak

Rita

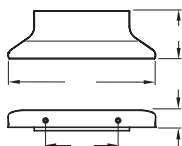
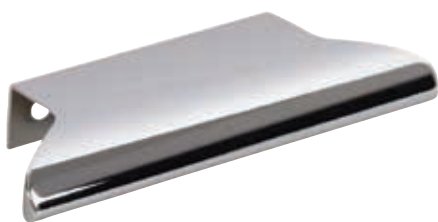

<input checked="" type="radio"/>	
<input type="radio"/>	
<input type="radio"/>	
<input checked="" type="radio"/>	126.45.052
Matt black	



Dimensional data not binding. We reserve the right to alter specifications without notice.

AT A GLANCE

KITCHEN APPLICATIONS

BEDROOM APPLICATIONS

BATHROOM APPLICATIONS

HANDLE FREE APPLICATIONS

INSTALLATION & DISPLAY

Cutt



Aspekt cabinet doors from - Hampstead ultragloss stone grey featured with Cutt pull handles in matt black finish

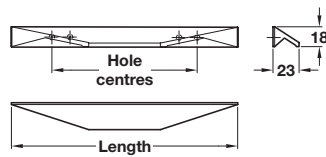

CUTT pull handle

- > 2x M4 x 25 mm handle screws included
- > Aluminium
- > Order qty: 1 pc



		s	Cat. No.
●	200 mm	96/128 mm	155.02.360
			155.02.361
●	200 mm	96/128 mm	106.60.316
		400 mm	192/320 mm
●	Polished chrome		



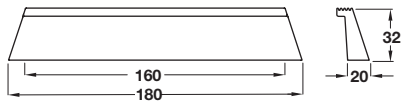
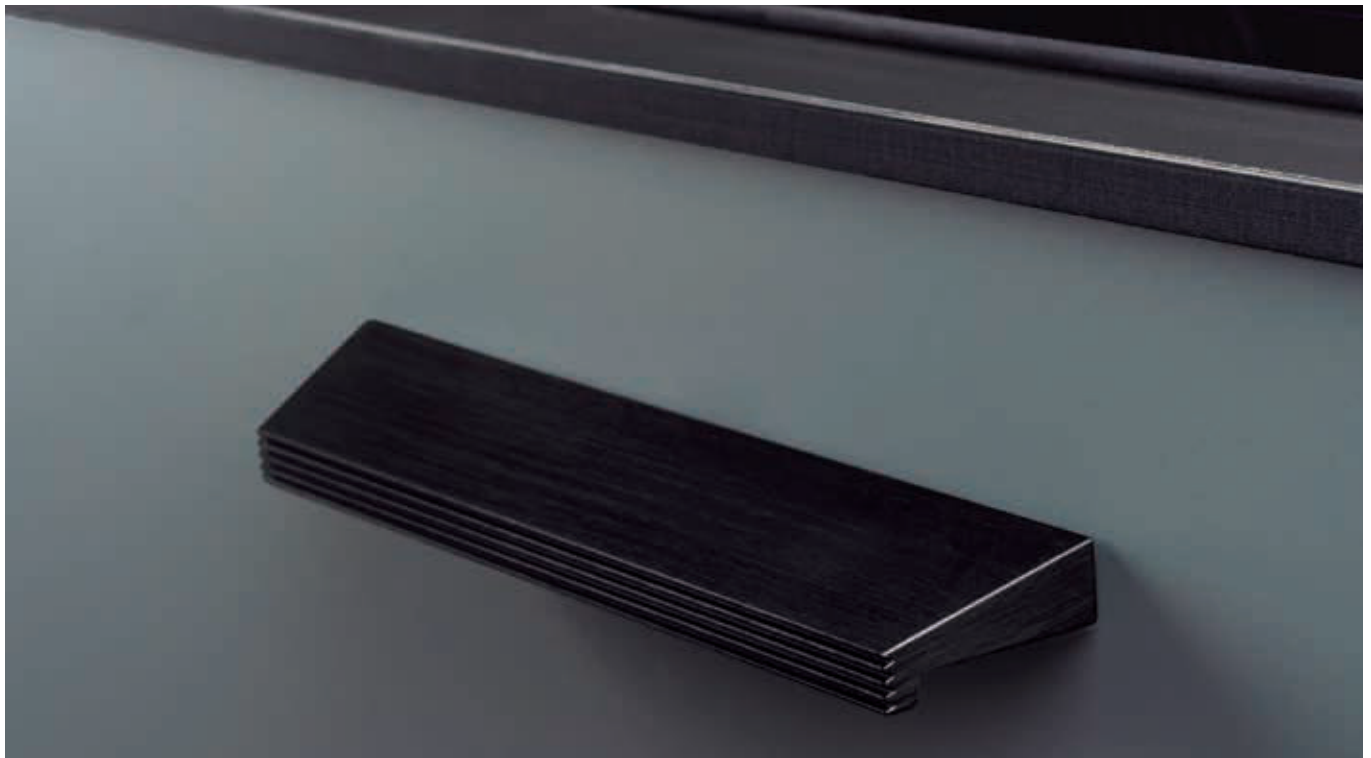

 View the full Aspekt cabinet doors range, visit www.ikea.co.uk/aspekt-doors



RAIL pull handle

- > 2x M4 x 25 mm handle screw included
- > Aluminium
- > Order qty: 1 pc



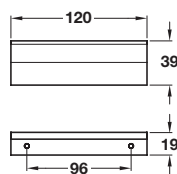

	Cat. No.
	106.60.319
 Brushed brass	106.60.320



RUBY trim handle

- > 2x Ø 3.0 x 13 mm countersunk head screws included
- > Brass
- > Order qty: 1 pc



	Cat. No.
	112.84.024
 Polished nickel	112.84.724

Note: ± 3 mm tolerance on non-critical dimensions and ±1 mm on hole centre dimensions

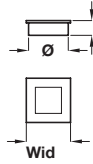

SAUL inset handle

- > Press-fit
- > Zinc alloy
- > Order qty: 1 pc

	Width	Diameter	Cat. No.
	39 mm	Ø 35 mm	151.94.201
	50 mm	Ø 44 mm	151.94.202
	39 mm	Ø 35 mm	151.94.601
	50 mm	Ø 44 mm	151.94.602
	39 mm	Ø 35 mm	151.94.401

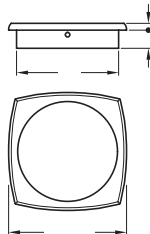

MAGNUS inset handle

- > Order M4 handle screws separately
- > Brass, polished chrome finish with aluminium coloured inner
- qty: 1 pc



	Width	Diameter	Dim. A	Cat. No.
	44 mm	Ø 38 mm	7 mm	151.19.212



Don't forget to order M4 handle screws, see page **353**

For our full range of fixing materials and installation tools see the Installation & Display section, pages **350-353**

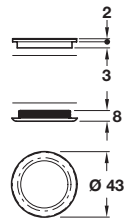

EPTE inset handle

- > Suitable for sliding glass doors 4-6 mm thick
- > Requires \varnothing 37 mm hole
- > Brass
- > Order qty: 1 pc

	Cat. No.
 Polished nickel-plated	154.00.727

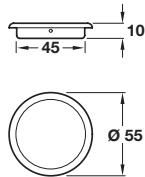

AARON inset e

- > Suitable for timber cabinet/wardrobe doors
- > Order round-head metal pin, \varnothing 1.6 separately
- > Steel
- > Order qty: 1 pc



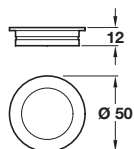

	Cat. No.
 Polished nickel-plated / Matt inside	153.20.733



INDRE inset handle

- > Suitable for timber cabinet/wardrobe doors
- > Requires \varnothing 42 mm hole
- > Press-in fixing

	Cat. No.
	153.20.630
 Polished chrome	153.20.230

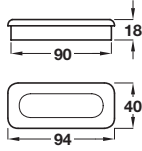

Product is subject to variations in colour and dimensions due to being manufactured from natural materials

MONTONE inset handle

- > Order M4 handle screws separately
- > Unfinished wood
- > Order qty: 1 pc



	Cat. No.
 Oak	192.52.405

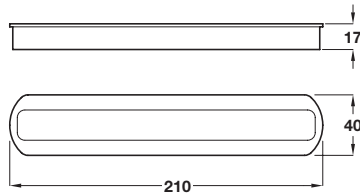

Product is subject to variations in colour and dimensions due to being manufactured from natural materials

HALKIN inset handle

- > Order M4 handle screws separately
- > Unfinished wood
- > Order qty: 1 pc



	Cat. No.
 Oak	192.29.422



Don't forget to order M4 handle screws, see page **353**

For our full range of fixing materials and installation tools see the Installation & Display section, pages **350-353**

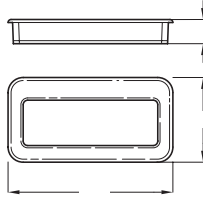

VIENNE Inset handle

- > Order M4 handle screws separately



	Cat. No.
 Matt chrome	151.35.208

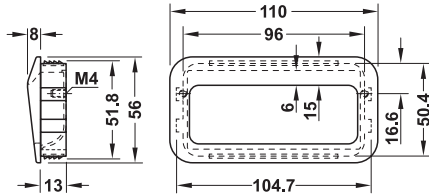

AVEBURY Inset handle

- > Order M4 handle screws separately
- > Harpoon-type fixing
- > Zinc alloy



	Cat. No.
 Matt nickel	155.00.540

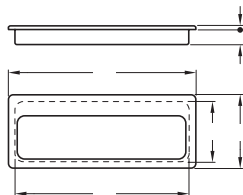

CAVU Inset handle

- > Order round-head metal pin, Ø 1.6 mm separately
- > Steel
- > Order qty: 1 pc

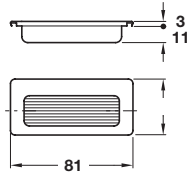

	Cat. No.
 Matt black	151.00.312

**ROYA inset handle**

- > Order round-head metal pin, Ø 1.6 separately
- > Brass
- > Order qty: 1 pc

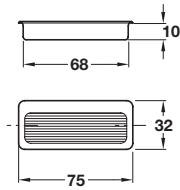

	Cat. No.
 Polished chrome / Matt black inside	151.14.235

**AROS inset handle**

- > Order round-head metal pin, Ø 1.6 separately
- > Brass
- > Order qty: 1 pc

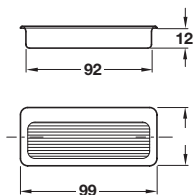

Finish	Cat. No.
 Polished chrome / Matt inside	155.01.545

**BESBRE inset handle**

- > Order round-head metal pin, Ø 1.6 separately
- > Brass
- > Order qty: 1 pc



Finish	Cat. No.
 Polished chrome / Matt inside	155.01.546



Don't forget to order M4 handle screws, see page **353**

For our full range of fixing materials and installation tools see the Installation & Display section, pages **350-353**

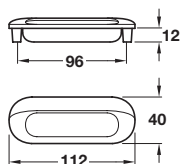

RHIN Inset handle

- > Order M4 handle screws separately
- > Zinc alloy
- > Order qty: 1 pc



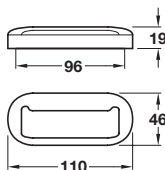

	Cat. No.
 Polished chrome / Aluminium coloured inside	151.17.209



AUTHIE Pull handle

- > Order M4 handle screws separately
- > Zinc alloy
- > Order qty: 1 pc



Finish	Cat. No.
	151.37.256
 Matt nickel	151.37.658



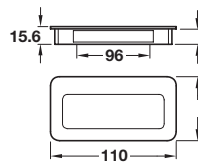
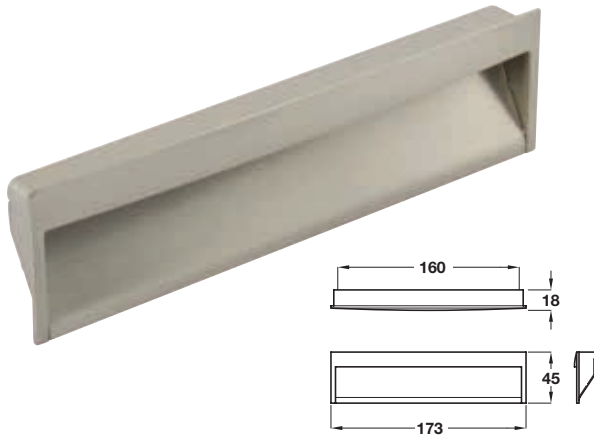

These handles should only be used with solid doors

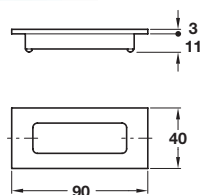

CAVENDISH inset handle



- > 2x M4 x 25 mm handle screws included
- > Zinc alloy
- > Order qty: 1 pc



	Cat. No.
 Stainless steel effect	151.11.613

ately



	Cat. No.
 Matt nickel-plated	151.35.262
 Matt nickel-plated	151.35.665

MAINE inset handle

- > Concealed fixing
- > 2x Ø 3.5 x 20 mm screws included
- > Brass
- > Order qty: 1 pc



	Cat. No.
 Stainless steel effect	151.73.601



Cubic



Matt white finish shown on both gloss dark grey or dark wood doors

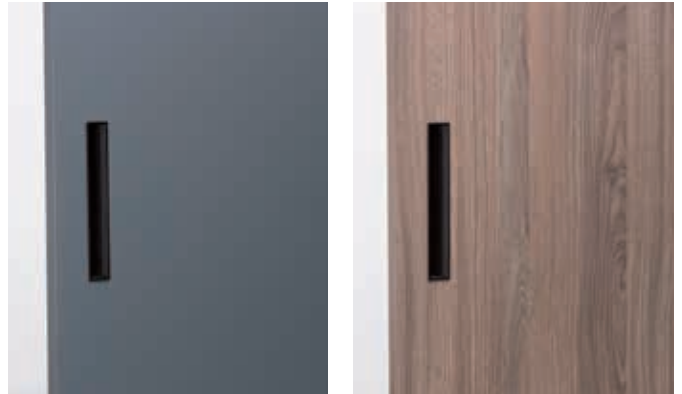

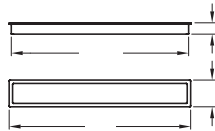

Matt black finish shown on both gloss dark grey or dark wood doors



CUBIC inset handle

> Press-in fixing



	Cat. No.
	151.11.640
 Matt black	151.11.641

Dimensional data not binding. We reserve the right to alter specifications without notice.

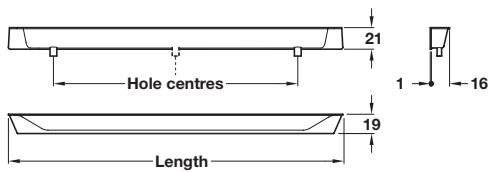

SINTESI Inset handle

- > Order M4 handle screws separately
- > Zinc alloy
- > Order qty: 1 pc



		entres	Cat. No.
	200 mm	128 mm	111.44.282

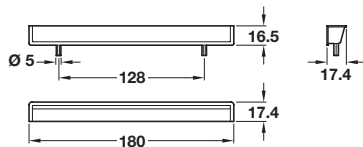

HIDE Inset handle

- > Ø 5 mm lugs

	Cat. No.
	151.47.662
	151.47.664
	151.47.665

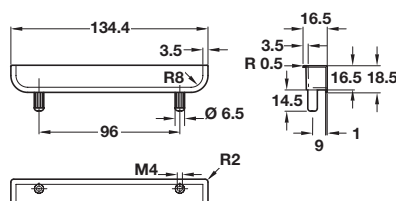

KATO inset handle

- > Press fit with Ø 6.5 mm lugs
- el effect with brushed edges

		Hole centres	Cat. No.
	134.4 mm	96 mm	126.54.090

Pellipar

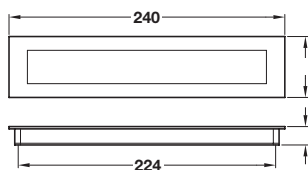

PELLIPAR inset handle frame and backplate set

- > Reversible backplate included, white/silver reverse
- > Zinc alloy
- > Order qty: 1 pc



	Cat. No.
 Stainless steel effect	153.22.000



Don't forget to order M4 handle screws, see page **353**
 For our full range of fixing materials and installation tools see the Installation & Display section, pages **350-353**

Bartram

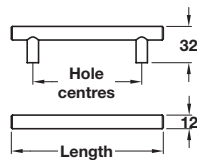

BARTRAM bar handle

- > *2x M4 x 20 mm, 2x M4 x 22 mm and 2x M4 x 25 mm screws included
- > Steel



			Cat. No.
	178 mm	128 mm	117.97.062
	220 mm	160 mm	117.97.063*
	178 mm	128 mm	117.97.162
	220 mm	160 mm	117.97.163



Don't forget to order M4 handle screws, see page **353**

For our full range of fixing materials and installation tools see the Installation & Display section, pages **350-353**

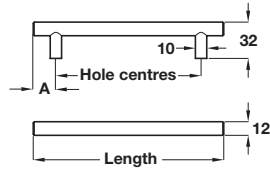

BARKSTON bar handle, Ø 12 mm

- > *2 each of M4 x 45 mm snap off handle screws included (101.20.700 includes an additional 1x M4 x 25 mm screw)
- > Order M4 handle screws separately
- > Steel
- > Order qty: 1 pc



		res	Dim. A	Cat. No.
 Stainless steel effect	136 mm	96 mm	20 mm	101.20.709
	168 mm	128 mm	20 mm	101.20.700*
	226 mm	156 mm	35 mm	101.20.701*
	230 mm	160 mm	35 mm	101.20.710*
	232 mm	192 mm	20 mm	101.20.708
	326 mm	256 mm	35 mm	101.20.702*
	376 mm	306 mm	35 mm	101.20.703*
	426 mm	356 mm	35 mm	101.20.704
	526 mm	456 mm	35 mm	101.20.705
	702 mm	632 mm	35 mm	101.20.706
828 mm	758 mm	35 mm	101.20.707*	

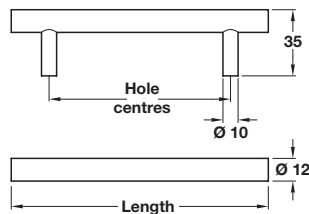



BELLA bar handle, Ø 12 mm

- > Order M4 handle screws separately
- > Steel
- > Order qty: 1 pc

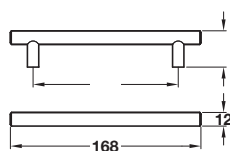

	ength	Hole centres	Cat. No.
 Polished chrome	136 mm	96 mm	117.97.224
	168 mm	128 mm	117.97.225
	200 mm	160 mm	117.97.218
	232 mm	192 mm	117.97.227
	328 mm	288 mm	117.97.219
	392 mm	352 mm	117.97.229



	No.
 Matt black epoxy	101.20.325

Pimlico

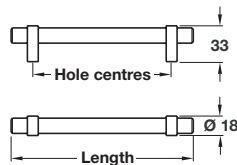

PIMLICO bar handle

- > Order M4 handle screws separately
- > Steel bar with zinc alloy feet
- > Order qty: 1 pc



		entres	Cat. No.
 Stainless steel effect	168 mm	128 mm	115.66.045
	232 mm	192 mm	115.66.045
	264 mm	224 mm	115.66.047
	424 mm	384 mm	115.66.048



Don't forget to order M4 handle screws, see page **353**
 For our full range of fixing materials and installation tools see the Installation & Display section, pages **350-353**

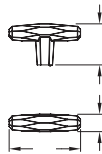
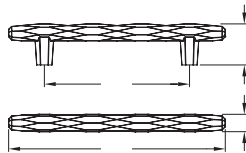



	133.50.639

Golden champagne



All handles on this page include 8/32 x 1" (non-metric) screws. If you require a different length order non-metric cut off screw Cat. No. 022.24.881 shown on page **353**

Boston

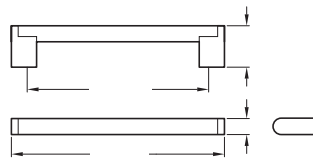

- > Order M4 handle screws separately
- > *2x M4 x 25 mm, 2x M4 x 25 mm and 2x M4 x 28 mm screws included
- > Zinc alloy ends, with hollow stainless steel tube or solid steel bar
- > Order qty: 1 pc



Stainless steel effect

	Hole centres	Cat. No.
Hollow stainless steel tube		
156 mm	128 mm	115.69.002
188 mm	160 mm	115.69.003*
220 mm	192 mm	115.69.004
237 mm	209 mm	104.74.011
284 mm	256 mm	115.69.006
337 mm	309 mm	104.74.012
348 mm	320 mm	115.69.008
387 mm	359 mm	104.74.013
437 mm	409 mm	104.74.014
476 mm	448 mm	115.69.009
537 mm	509 mm	104.74.015
Solid steel bar		
751 mm	709 mm	104.74.016
849 mm	807 mm	104.74.017
951 mm	909 mm	104.74.018
1199 mm	1157 mm	104.74.019

Osaka

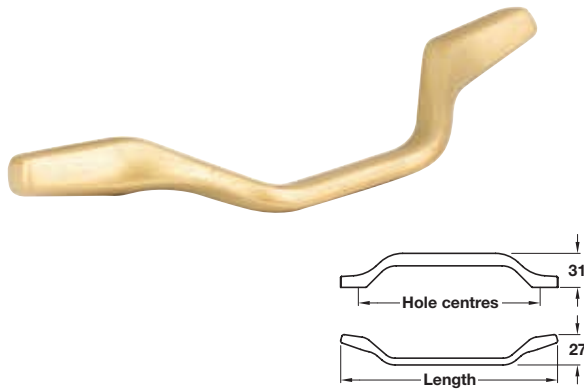

OSAKA pull handle

- > Fixings included:
 - Satin brass - 2x M4 x 50 mm snap-off handle screws
 - Antique copper and graphite - 2 each of M4 x 22 mm and M4 x 26 mm handle screws
- > Zinc alloy
- > Order qty: 1 pc



		entres	Cat. No.
●	mm	96 mm	110.22.080
	mm	160 mm	110.22.081
● er	191 mm	160 mm	110.22.086
	351 mm	320 mm	110.22.089
● Graphite	191 mm	160 mm	110.22.586

Dimensional data not binding. We reserve the right to alter specifications without notice.

Level

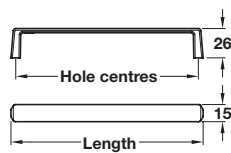

LEVEL pull handle

> Order M4 handle screws separately



		entres	Cat. No.
● Matt anthracite	72 mm	64 mm	111.71.505
	168 mm	160 mm	111.71.506
	328 mm	320 mm	111.71.507

Oval

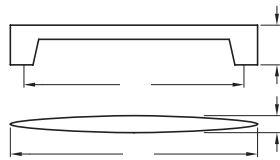

Product is subject to variations in colour and dimensions d

OVAL handle

- > Order M4 handle screws separately
- > Walnut, lacquered
- > Order qty: 1 pc



	Cat. No.
 Walnut	193.18.757



page **353**
 Installation tools see the Installation & Display section, pages **350-353**

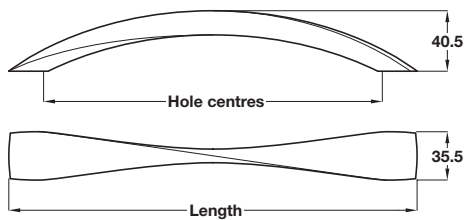

Product is subject to variations in colour and dimensions due to being manufactured from natural materials

TWIST pull handle

- > Order M4 handle screws separately
- > Oak
- > Order qty: 1 pc



		e centres	Cat. No.
 Oak unfinished	270 mm	224 mm	193.43.428
	388 mm	320 mm	193.43.429



Graf & Graf 2

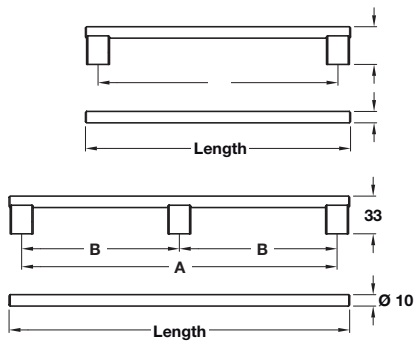
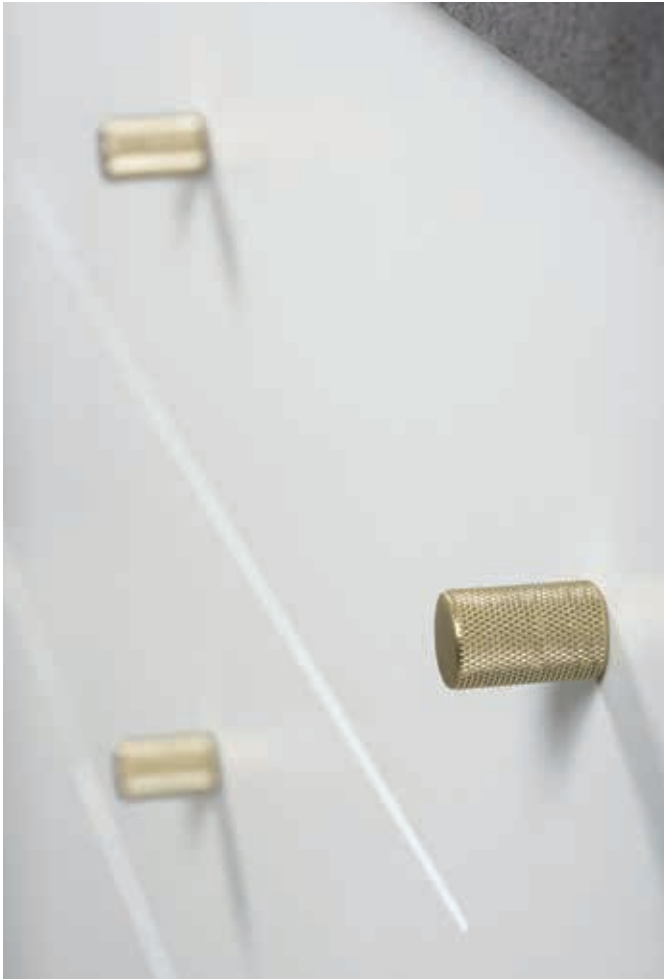

AF 2 bar handle

3x M4 x 25 mm handle screws included



actions without notice.



	182 mm	160 mm	-	132.19.120
	278 mm	256 mm	-	132.19.121
	1200 mm	1178 mm	589 mm	132.19.122

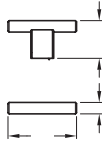

GRAF 2 T knob

- > 1x M4 x 25 mm handle screw included
- > Aluminium
- > Order qty: 1 pc



	Cat. No.
	132.19.105
	132.19.106
Brushed dark brass	132.19.107

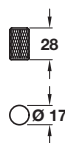

GRAF knob

- > 1x M4 x 25 mm handle screw included
- > Aluminium
- > Order qty: 1 pc



Finish	Cat. No.
Polished chrome	132.15.230
Brushed brass	132.19.210
Matt black	132.19.211
Stainless steel effect	132.15.630
Brushed dark brass	106.60.318

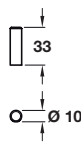

GRAF 2 cylindrical knob

- > 1x M4 x 25 mm handle screw included
- > Aluminium
- > Order qty: 1 pc



	Cat. No.
effect	132.19.100
	132.19.101
Brushed dark brass	132.19.102

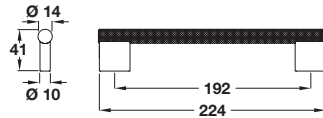

	No.
	112
	.110
Brushed dark brass	106.66.111

GRAF BIG knob

- > 1x M4 x 25 mm handle screw included
- > Aluminium
- > Order qty: 1 pc



Finish	Ø 38 mm	Ø 50 mm
Stainless steel effect	106.66.102	106.66.105
shed black	106.66.100	106.66.103
Dark brass	106.66.101	106.66.104



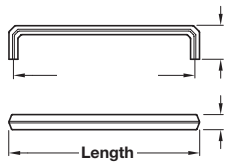
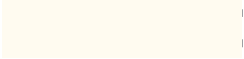

<input checked="" type="checkbox"/>				
<input type="checkbox"/>				
<input type="checkbox"/>				
<input type="checkbox"/>				
<input checked="" type="checkbox"/>	Matt black	168 mm	160 mm	113.96.121

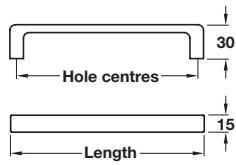

<input checked="" type="checkbox"/>				
<input type="checkbox"/>				
<input type="checkbox"/>				
<input type="checkbox"/>				
<input checked="" type="checkbox"/>	Matt black	172 mm	160 mm	113.96.100
<input type="checkbox"/>	Matt black	332 mm	320 mm	113.96.101

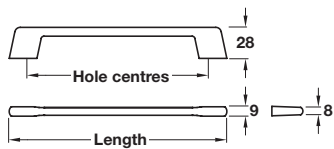

<input checked="" type="checkbox"/>				
<input type="checkbox"/>				
<input type="checkbox"/>				
<input type="checkbox"/>				
<input checked="" type="checkbox"/>	Matt black	153 mm	128 mm	113.96.110
<input type="checkbox"/>	Matt black	185 mm	160 mm	113.96.111



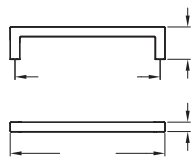
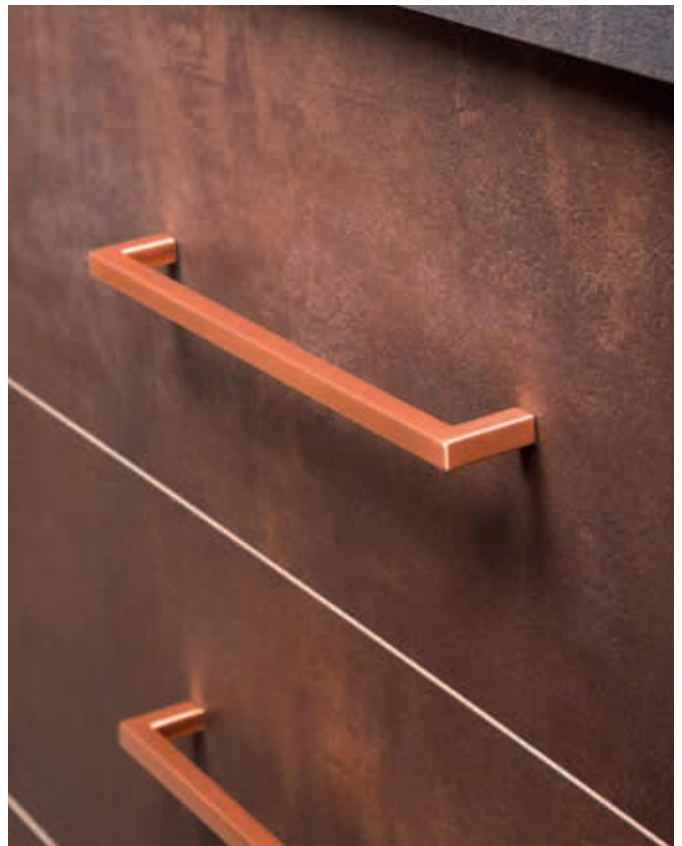

2x M4 x 25 mm handle screws included
 Zinc alloy
 Order qty: 1 pc



●			
●			6.285
			6.380
			6.286
			6.287
●			6.388
			6.389
			6.390
			6.391
●	136.5 mm	128 mm	108.66.376
Brushed copper	200.5 mm	192 mm	108.66.377
	328.5 mm	320 mm	108.66.378
	500.5 mm	492 mm	108.66.379



ESTE pull handle



<input checked="" type="checkbox"/>		
<input type="checkbox"/>		
<input type="checkbox"/>		
<input type="checkbox"/>		5
<input type="checkbox"/>	Brushed copper	108.66.455

➔ The COMO knob shown on page **265** matches the ESTE pull handle

Burbridge

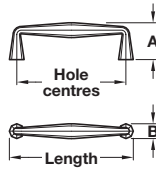

*Product is subject to variations in finish due to the finishing and manufacturing process of certain materials

BRIDGE pull handle



- > 2x M4 x 25 mm handle screws included
- > Brass or cast iron
- > Order qty: 1 pc



		e _s	Dim. A	Dim. B	Cat. No.
		m	35 mm	15 mm	116.35.745
		m	37 mm	15 mm	116.35.746
		mm	35 mm	15 mm	116.35.545
		mm	35 mm	15 mm	116.35.945
	109 mm	96 mm	33 mm	13 mm	116.35.344
	212 mm	192 mm	40 mm	17 mm	116.35.347

BURBRIDGE knob



- > 1x M4 x 25 mm handle screw included
- > Brass
- > Order qty: 1 pc

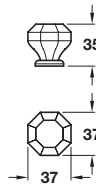

*Product is subject to variations in finish due to the finishing and manufacturing process of certain materials

	Cat. No.
ss*	123.03.510
Polished nickel	123.03.710

Dimensional data not binding. We reserve the right to alter specifications without notice.

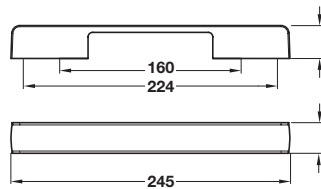

BLANCO D handle

- > Order M4 handle screws separately
- > Zinc alloy, with acrylic centres



	Cat. No.
 Polished chrome with white insert	111.21.273

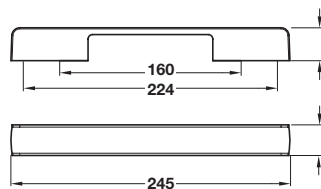

NOIR D handle

- > Order M4 handle screws separately



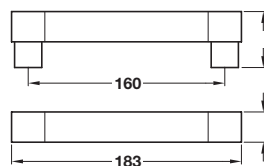

	at. No.
 Polished chrome with black insert	111.21.233



DOMINO bar handle

- > Order M4 handle screws separately
- > Zinc alloy, polished chrome with leather effect centre
- > Order qty: 1 pc



	Length	Hole centres	Cat. No.
	151 mm	128 mm	113.98.232
	183 mm	160 mm	113.98.233
	151 mm	128 mm	113.98.212
	247 mm	224 mm	113.98.215



Don't forget to order M4 handle screws, see page **353**
 For our full range of fixing materials and installation tools see the Installation & Display section, pages **350-353**

Crystal

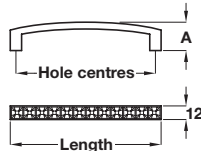

CRYSTAL D handle

- > Order M4 handle screws separately
- > Made with CRYSTALLIZED™ Swarovski Elements
- > Zinc alloy



				. No.
	107 mm	96 mm	22 mm	103.29.221
	140 mm	128 mm	25 mm	103.29.222

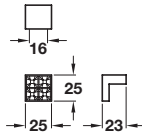

CRYSTAL pull handle

- > Order M4 handle screws separately
- > Made with CRYSTALLIZED™ Swarovski Elements
- > Zinc alloy
- > Order qty: 1 pc



	Cat. No.
Polished chrome	132.19.240

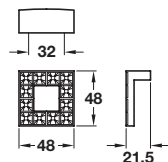

CRYSTAL pull handle

- > 2x M4 x 25 mm handle screws included
- > Made with CRYSTALLIZED™ Swarovski Elements
- > Zinc alloy
- > Order qty: 1 pc



	Cat. No.
Polished chrome	132.19.220

Glacio

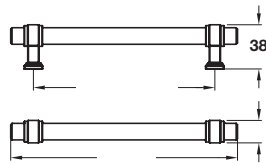

GLACIO pull handle

- > 2x 8/32 x 1" (non-metric) screws included
- > Zinc/Glass
- > Order qty: 1 pc



	Length	Hole centres	Cat. No.
	167 mm	128 mm	133.53.039
Polished nickel / Clear	200 mm	160 mm	133.53.040

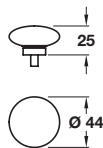
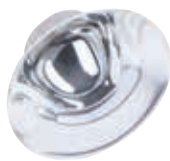

GLACIO knob

- > 1x 8/32 x 1" (non-metric) screw included
- > Zinc/Glass
- > Order qty: 1 pc



Finish	Cat. No.
	133.50.122
Polished nickel / Clear	

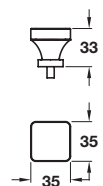

GLACIO square knob

- > 1x 8/32 x 1" (non-metric) screw included
- > Zinc/Glass
- > Order qty: 1 pc



Finish	Cat. No.
	133.50.120
Polished nickel / Clear	



➔ All handles on this page include 8/32 x 1" (non-metric) screw Cat. No. 022.24.881 shown on page **353**

re a different length order non-metric cut off

Byron

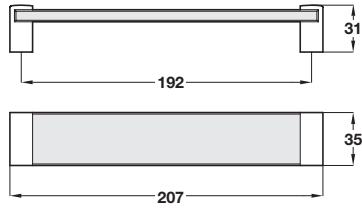

BYRON bar handle

- > 2x M4 x 25 mm handle screws included
- > Zinc alloy, with tempered glass



	108.80.507
Polished chrome with clear glass	

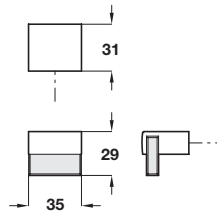

BYRON knob

- > 1x M4 x 25 mm handle screw included
- > Zinc alloy, with tempered glass
- > Order qty: 1 pc



	Cat. No.
	131.14.200
Polished chrome with clear glass	

Glitter

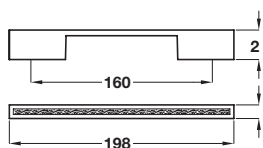

GLITTER D handle

> Order M4 handle screws separately



	Polished chrome with glitter inner, sealed	110.22.253
---	--	-------------------

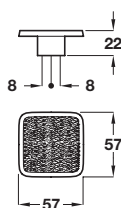

GLITTER knob

> Order M4 handle screws separately
 > Zinc alloy
 > Order qty: 1 pc



		Cat. No.
	Polished chrome with glitter inner, sealed	132.15.220

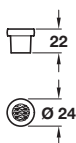

GLITTER knob

> Order M4 handle screws separately
 > Zinc alloy
 > Order qty: 1 pc



		Cat. No.
	Polished chrome with glitter inner, sealed	132.15.210

Dimensional data not binding. We reserve the right to alter specifications without notice.

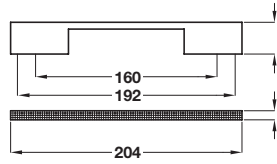

DISCO pull handle

- > Order M4 handle screws separately
- > Zinc alloy



	Cat. No.
 Polished chrome	110.22.243

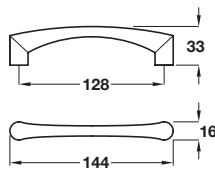

EMERSON D handle

- > 2x M4 x 45 mm snap off handle screws included



	Cat. No.
 Matt nickel	101.71.022



Don't forget to order M4 handle screws, see page **353**

For our full range of fixing materials and installation tools see the Installation & Display section, pages **350-353**

Dimple

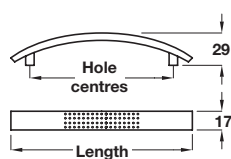

DIMPLE bow handle

- > Order M4 handle screws separately
- > Zinc alloy



		Hole centres	Cat. No.
		96 mm	101.69.201
		128 mm	101.69.202
		96 mm	101.69.601
		128 mm	101.69.602
	126 mm	96 mm	101.69.001
	158 mm	128 mm	101.69.002

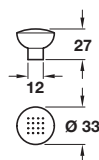

DIMPLE knob

- > Order M4 handle screws separately
- > *1x M4 x 25 mm screw included
- > Zinc alloy



	Cat. No.
	135.48.202
	135.48.402
	135.48.002*

Dimensional data not binding. We reserve the right to alter specifications without notice.

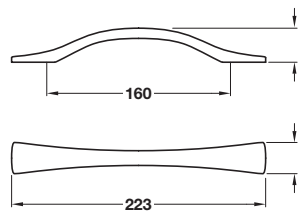

TARA bow handle

- > Order M4 handle screws separately
- > Zinc alloy



	o.
	105.77.603

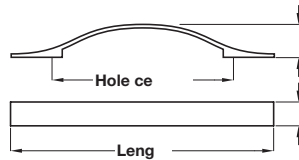

Matt nickel



CHISWICK bow handle

- > Order M4 handle screws separately
- > Zinc alloy



	No.
	108.89.243
	108.89.043

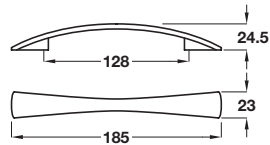

Stainless steel effect



QUIGLEY bow handle

- > Order M4 handle screws separately
- > Zinc alloy



	Cat. No.
	109.29.202
	109.29.602
	109.29.402

Aluminium coloured



Don't forget to order M4 handle screws, see page **353**

For our full range of fixing materials and installation tools see the Installation & Display section, pages **350-353**

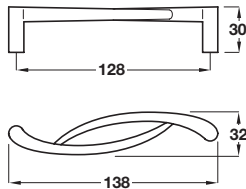

SOPHIA pull handle

- > Order M4 handle screws separately
- > Zinc alloy



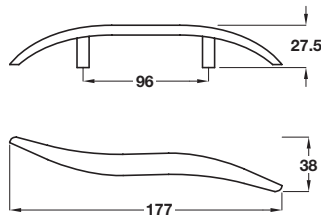

	Cat. No.
 Matt nickel	101.50.602



SILAS bar handle

- > Order M4 handle screws separately
- > Zinc alloy



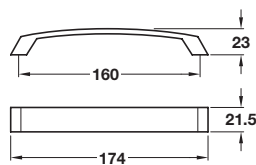

	Cat. No.
 Matt nickel	103.36.600
 Polished chrome	103.36.201



TAVISTOCK bow handle

- > 2 each of M4 x 22 mm and M4 x 25 mm handle screws included
- > *2x M4 x 45 mm snap off handle screws included
- > Aluminium



	No.
 Matt nickel	226
 Stainless steel effect	109.53.626*

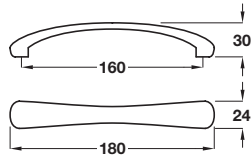

AUBREY bow handle

- > Order M4 handle screws separately
- > Zinc alloy
- > Order qty: 1 pc



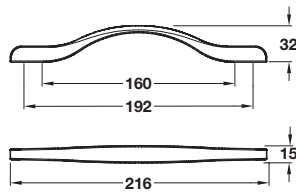

	Cat. No.
 Matt nickel	109.13.603



HENLEY bow handle

- > Order M4 handle screws separately
- > Zinc alloy
- > Order qty: 1 pc



	Cat. No.
 Graphite	108.89.116
 Graphite	108.89.516



page **353**

Installation tools see the Installation & Display section, pages **350-353**

Arc

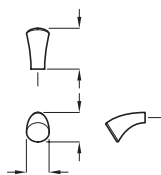
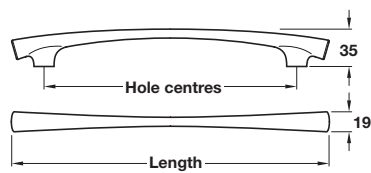

Polished chrome	185 mm	128 mm	111.62.212
	281 mm	224 mm	111.62.215



--	--	--	--

Dimensional data not binding. We reserve the right to alter specifications without notice.

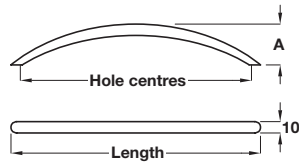

INDIGO bow handle

- > Order M4 handle screws separately
- > Steel
- > Order qty: 1 pc



		Hole centres	Dim. A	Cat. No.
			30 mm	117.31.222
		m	30 mm	117.31.231
		m	32 mm	117.31.241
		m	32 mm	117.31.261
	151 mm	128 mm	30 mm	106.43.302
	187 mm	160 mm	32 mm	106.43.303

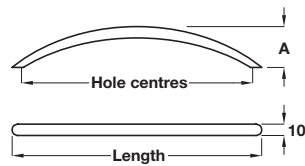

Bow handle

- > Order M4 handle screws separately



			im. A	Cat. No.
			4 mm	106.43.401
			0 mm	106.43.402
			2 mm	106.43.403
			0 mm	106.43.407
	118 mm	96 mm	24 mm	106.43.801
	151 mm	128 mm	30 mm	106.43.802
	187 mm	160 mm	32 mm	106.43.803
	320 mm	288 mm	40 mm	106.43.807

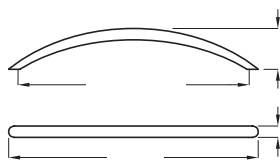

CLIFTON bow handle

- > Order M4 handle screws separately
- > *2x M4 handle screws included



			Dim. A	Cat. No.
	111 mm	96 mm	30 mm	117.31.021
	148 mm	128 mm	30 mm	117.31.031*
	184 mm	160 mm	32 mm	117.31.041
	221 mm	192 mm	32 mm	117.31.052
	258 mm	224 mm	32 mm	117.31.053
	332 mm	288 mm	32 mm	117.31.071

Cordelia

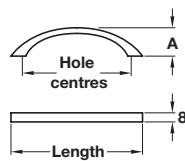

CORDELIA bow handle

- > Order M4 handle screws separately
- > Zinc alloy



		res	Dim. A	Cat. No.
 Polished chrome	86.5 mm	64 mm	19 mm	107.66.210
	150 mm	128 mm	31 mm	107.66.212
	186 mm	160 mm	31.5 mm	107.66.213
	318 mm	288 mm	38.5 mm	107.66.217



Don't forget to order M4 handle screws, see page **353**
 For our full range of fixing materials and installation tools see the Installation & Display section, pages **350-353**

Knightsbridge

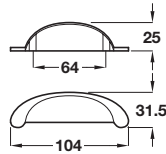

KNIGHTSBRIDGE cup handle

- > Order M4 handle screws separately
- > Zinc alloy
- > Order qty: 1 pc



	Cat. No.
 Stainless steel effect	118.55.620

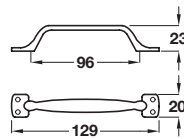

KNIGHTSBRIDGE D handle

- > Order M4 handle screws separately



	Cat. No.
 Stainless steel effect	118.69.620



Don't forget to order M4 handle screws, see page **353**

For our full range of fixing materials and installation tools see the Installation & Display section, pages **350-353**

Henrietta

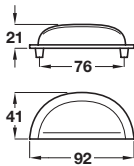

+ The MAYBERRY knob shown on page 133 also matches the HENRIETTA cup handle

HENRIETTA cup handle



- > 2x M4 x 25 mm and 2x M4 x 45 mm snap off handle screws included
- > *Order M4 handle screws separately
- > Zinc alloy
- > Order qty: 1 pc



	Cat. No.
	166.11.204*
	166.11.400*
Polished black nickel	166.11.305

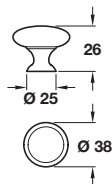

HENRIETTA knob



- > 1x M4 x 25 mm handle screw included
- > Zinc alloy
- > Order qty: 1 pc



Finish	Cat. No.
ed chrome	134.39.210
Stainless steel effect	134.39.020

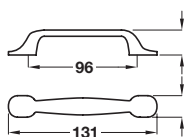

HENRIETTA D handle



- > 2x M4 x 25 mm handles screws and 2x M4 x 45 mm snap off handle screws included
- > *Order fixing screws separately
- > Aluminium



	Cat. No.
	109.48.224
Stainless steel effect	118.53.600*

Ariel

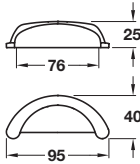

ARIEL cup handle

- > 2 each of M4 x 20 mm, 22 mm and 27 mm handle screws included
- > *Order fixing screws separately for polished chrome finish
- > Zinc alloy
- > Order qty: 1 pc



	Cat. No.
	166.11.240*
Pewter effect	166.11.905

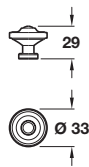

ARIEL knob

- > 1 each of M4 x 22 mm and 27 mm handle screws included
- > *Order fixing screws separately for polished chrome finish
- > Zinc alloy
- > Order qty: 1 pc



	Cat. No.
Polished chrome	134.06.200*
Pewter effect	166.11.900



Don't forget to order M4 handle screws, see page **353**

For our full range of fixing materials and installation tools see the Installation & Display section, pages **350-353**

Odessa

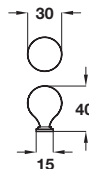
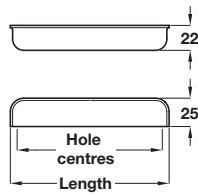

ODESSA cup handle

- > Order M4 handle screws separately
- > Zinc alloy
- > Order qty: 1 pc



	Length	Hole centres	Cat. No.
me	78 mm	64 mm	151.40.660
	140 mm	128 mm	151.40.665
effect	78 mm	64 mm	151.40.661
	140 mm	128 mm	151.40.666
Brushed copper	78 mm	64 mm	151.40.662
	140 mm	128 mm	151.40.667



ODESSA knob

- > Order M4 handle screws separately
- > Zinc alloy
- > Order qty: 1 pc



Finish	Cat. No.
Polished chrome	110.35.360
Stainless steel effect	110.35.361
Brushed copper	110.35.362



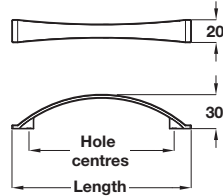

ODESSA bow handle

- > Order M4 handle screws separately
- > Zinc alloy
- > Order qty: 1 pc



	Hole centres	Cat. No.
	128 mm	107.03.610
		107.03.611
 Brushed copper		107.03.613

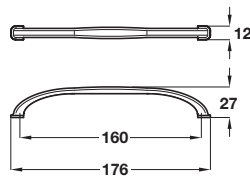

ODESSA bow handle

- > Order M4 handle screws separately
- > Zinc alloy



	Cat. No.
	107.03.615
	107.03.616
 Brushed copper	107.03.617



Don't forget to order M4 handle screws, see page **353**
 For our full range of fixing materials and installation tools see the Installation & Display section, pages **350-353**



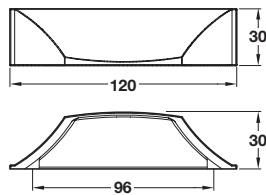

Augusta



AUGUSTA cup handle

- > Order M4 handle screws separately
- > Zinc alloy
- > Order qty: 1 pc



	Cat. No.
 effect	118.68.104
 effect	118.68.704
 Polished chrome	118.68.204
 Antique copper	118.68.804
 Antique copper	118.68.004

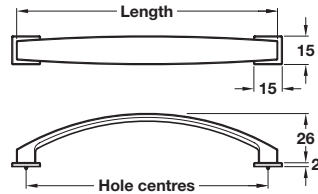

AUGUSTA bow handle with backplates

- > Order M4 handle screws separately
- > Use with or without backplates
- > Zinc alloy
- > Order qty: 1 set



		Hole centres	Cat. No.
		128 mm	103.30.105
		160 mm	103.30.106
		128 mm	103.30.705
		160 mm	103.30.706
		128 mm	103.30.205
		160 mm	103.30.206
		128 mm	103.30.805
		160 mm	103.30.806
	138 mm	128 mm	103.30.005
	170 mm	160 mm	103.30.006

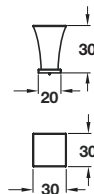
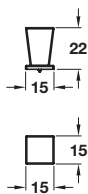

AUGUSTA knob with backplate

- > Order M4 handle screws separately
- > Use with or without backplate
- > Zinc alloy
- > Order qty: 1 set



Finish	15 x 15 mm	30 x 30 mm
s steel effect	110.35.380	110.35.392
nickel	110.35.381	-
chrome	110.35.382	110.35.390
ck	110.35.384	110.35.393
Antique copper	110.35.383	110.35.394



Don't forget to order M4 handle screws, see page **353**

For our full range of fixing materials and installation tools see the Installation & Display section, pages **350-353**

Kane

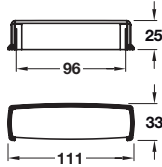

Product is subject to variations in finish due to the finishing and manufacturing process of certain materials

KANE cup handle

- > 2x 8/32 x 1" (non-metric) screws included
- > Zinc alloy
- > Order qty: 1 pc



	Cat. No.
 Oil rubbed bronze	133.50.140

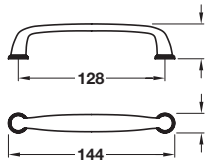

Product is subject to variations in finish due to the finishing and manufacturing process of certain m

KANE pull handle



	at. No.
 Oil rubbed bronze	133.50.340

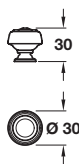

Product is subject to variations in finish due to the finishing and manufacturing process of certain materials

KANE knob

- > 1x 8/32 x 1" (non-metric) screw included
- > Zinc alloy
- > Order qty: 1 pc



Finish	Cat. No.
 Oil rubbed bronze	133.50.609



All handles on this page include 8/32 x 1" (non-metric) screws. If you require a different length order non-metric cut off screw Cat. No. 022.24.881 shown on page 353

Crawford

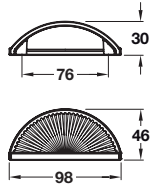



*Product is subject to variations in finish due to the finishing and manufacturing process of certain materials

CRAWFORD cup handle

- > 2x 8/32 x 1" (non-metric) screws included
- > Zinc alloy
- > Order qty: 1 pc



Finish	Cat. No.
 Golden champagne	133.50.143
 Oil rubbed bronze*	133.50.144

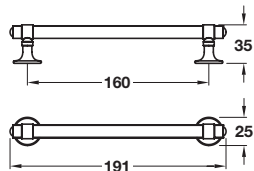
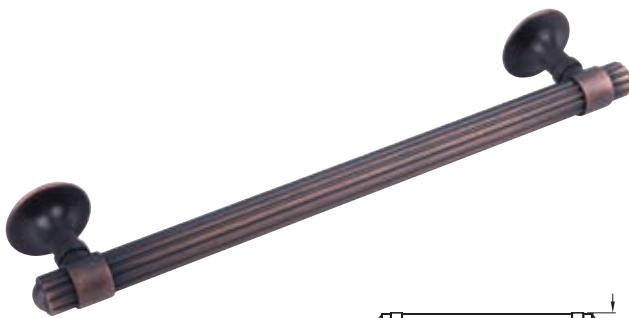



*Product is subject to variations in finish due to the finishing and manufacturing process of certain materials

CRAWFORD pull handle

- > 2x 8/32 x 1" (non-metric) screws included
- > Zinc alloy
- > Order qty: 1 pc



Finish	Cat. No.
 ampagne	133.50.374
 Oil rubbed bronze*	133.50.377

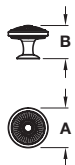



*Product is subject to variations in finish due to the finishing and manufacturing process of certain materials

CRAWFORD knob

- > 1x 8/32 x 1" (non-metric) screw included
- > Zinc alloy
- > Order qty: 1 pc



Finish	Dim. A	Dim. B	Cat. No.
 Golden champagne	Ø 35 mm	30 mm	133.50.303
 Oil rubbed bronze*	Ø 35 mm	30 mm	133.50.305

Cotswold

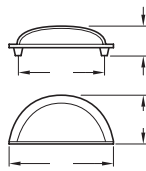

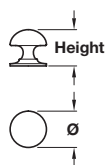

- > 1x M4 x 50 mm handle screw included
- > Brass
- > Order qty: 1 pc

	Diameter	Height	Cat. No.
	Ø 31 mm	32 mm	134.97.710
	Ø 38 mm	39 mm	134.97.711
 Brushed copper	Ø 38 mm	39 mm	134.97.011

Note: ± 3 mm tolerance on non-critical dimensions and ±1 mm on hole centre dimensions
Product is subject to variations in finish due to the finishing and manufacturing process of certain materials



Brushed copper has not been lacquered and will change naturally over time

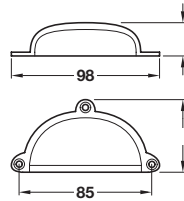

Note: ± 3 mm tolerance on non-critical dimensions and ±1 mm on hole ce

*Product is subject to variations in finish due to the finishing and manufacturing process of

COTSWOLD cup handle

- > 3x Ø 3.5 x 20 mm raised head screws included
- > Brass
- > Order qty: 1 pc



	Cat. No.
	166.08.700
	166.08.100
Polished brass	166.08.800

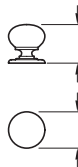

Note: ± 3 mm tolerance on non-critical dim

*Product is subject to variations in finish due to the finishing and manufacturing process of certain

COTSWOLD knob

- > 1x M4 x 50 mm snap off handle screw included
- > Brass
- > Order qty: 1 pc



	Diameter	Dim. A	Cat. No.
	Ø 31 mm	33 mm	133.32.710
	Ø 38 mm	36 mm	133.32.711
ed*	Ø 33 mm	33 mm	133.32.100
Polished brass	Ø 33 mm	33 mm	133.32.800

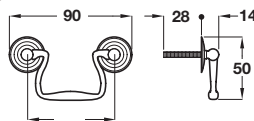

Note: ± 3 mm tolerance on

Product is subject to variations in finish due

COTSWOLD drop handle

- > 2x M4 spindle and nut included
- > Brass
- > Order qty: 1 pc



	Cat. No.
Bronzed and brushed	120.13.130

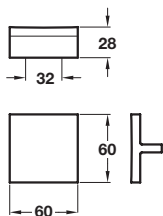

Bronzed and brushed has not been lacquered and will change naturally over time

**AMBER knob**

- > Order M4 handle screws separately
- > Zinc alloy
- > Order qty: 1 pc



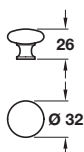

	Cat. No.
 Polished chrome	131.14.260

**ORIEL knob**

- > Order M4 handle screws separately
- > Zinc alloy
- > Order qty: 1 pc



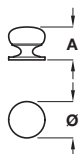

	Cat. No.
	134.02.600
	135.24.600
 Polished chrome	133.09.200

**GROSVENOR knob**

- > Order M4 handle screws separately
- > Brass
- > Order qty: 1 pc



	Diameter	Dim. A	Cat. No.
 Polished brass	Ø 32 mm	28 mm	137.00.224
	Ø 38 mm	30 mm	137.00.205
 Polished brass	Ø 32 mm	28 mm	137.00.822
	Ø 38 mm	30 mm	137.00.805



Don't forget to order M4 handle screws, see page **35**
For our full range of fixing materials and installation to

section, pages **350-353**

Rocher



Rocher knob Cat. No. 137.80.730 shown on round backplate Cat. No. 137.80.740

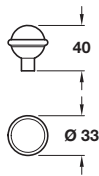

Note: ± 3 mm tolerance on non-critical dimensions

ROCHER knob

- > 1x M4 x 25 mm handle screw included
- > Brass
- > Order qty: 1 pc



	Cat. No.
 Polished nickel	137.80.730



BALLEY and SULA knobs shown on page **164** also available

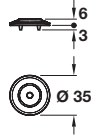

Note: ± 3 mm tolerance on non-critical dimensions

Round backplate

- > Order M4 handle screw separately
- > Brass
- > Order qty: 1 pc



	Cat. No.
 Polished nickel	137.80.740

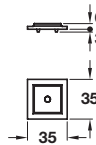

Note: ± 3 mm tolerance on non-critical dimensions

Square backplate

- > Order M4 handle screw separately
- > Brass
- > Order qty: 1 pc



	Cat. No.
 Polished nickel	137.80.750

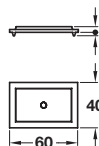

Note: ± 3 mm tolerance on non-critical dimensions

Rectangular backplate

- > Order M4 handle screw separately
- > Brass
- > Order qty: 1 pc



	Cat. No.
 Polished nickel	137.80.760

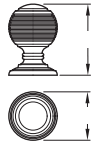

Note: ± 3 mm tolerance on non-critical dimensions and

JUPITER knob

- > 1x M4 x 25 mm handle screw included
- > Brass
- > Order qty: 1 pc



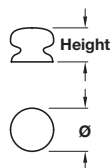

	Diameter	Height	Cat. No.
	Ø 32 mm	44 mm	123.02.080
Stainless steel effect	Ø 38 mm	52 mm	135.07.610



- > Order qty: 1 pc



	Diameter	Dim. A	Cat. No.
	Ø 38 mm	30 mm	130.48.701
	Ø 38 mm	30 mm	130.48.407
	Ø 38 mm	30 mm	130.48.309
Black	Ø 50 mm	39 mm	130.48.302

Timber Grain Knobs

Timber knobs are available in two versions, routed cross grain and turned end grain. Routed knobs have the cross grain on top, like you have on a wooden front. Turned knobs have the end grain on top of the knob



Cross grain knobs -

Individually routed from a fixed wooden block with a full shaped tool. Each knob is then sanded to the final shape. This method of manufacture makes for a higher quality knob that shows the natural wood grain to it's best



End grain knobs -

Traditional turned knobs are turned on a copy lathe from a long turning wood dowel and cut off automatically. This method of manufacture is faster and produces a more economical and cost effective product



Oak, unfinished





Beech, unfinished

Turned knob, end grain

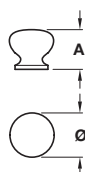
- > Order M4 handle screws separately
- > Wood, unfinished
- > Order qty: 1 pc



Product is subject to variations in colour and dimensions due to being manufactured from natural materials

	Diameter	Dim. A	Cat. No.
	Ø 34 mm	28 mm	195.75.401
	Ø 44 mm	38 mm	195.75.403
	Ø 34 mm	28 mm	195.75.301
	Ø 44 mm	38 mm	195.75.302

Beech



page **353**

Installation tools see the Installation & Display section, pages **350-353**

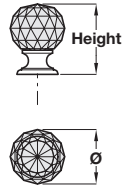

HARLEY knob

- > 1x M4 x 22 mm and 1x M4 x 25 mm handle screws included
- > Glass knob with brass base
- > Order qty: 1 pc



	gth	Height	Cat. No.
	Ø 30 mm	41 mm	139.60.422
	Ø 35 mm	45 mm	139.60.423

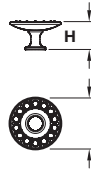

DIAMOND knob

- > Order M4 handle screws separately
- > Zinc alloy with Swarovski crystal
- > Order qty: 1 pc



	gth	Height	Cat. No.
	Ø 45 mm	27 mm	132.19.270

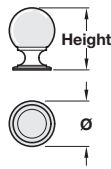

PRIMROSE knob

- > Order M4 handle screws separately
- > Zinc alloy with glass knob
- > Order qty: 1 pc



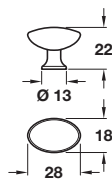

	Length	Height	Cat. No.
	Ø 25 mm	36 mm	139.60.400
	Ø 30 mm	41 mm	139.60.401



PEARL knob

- > Order M4 handle screws separately
- > Zinc alloy
- > Order qty: 1 pc



	Cat. No.
 ome	133.09.210
 el	133.09.410
 Brushed copper	133.09.010



Como

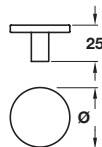

COMO knob

- > 1x M4 x 25 mm handle screw included
- > Zinc alloy
- > Order qty: 1 pc



	Cat. No.
	106.66.287
	106.66.285
	106.66.284
 Brushed copper	106.66.286



The ESTE pull handle shown on page 231 matches the COMO knob



View the full Aspekt cabinet doors range, visit www.ikea.co.uk/aspekt-doors

Dimensional data not binding. We reserve the right to alter specifications without notice.

AT A GLANCE

KITCHEN APPLICATIONS

BEDROOM APPLICATIONS

BATHROOM APPLICATIONS

HANDLE FREE APPLICATIONS

INSTALLATION & DISPLAY

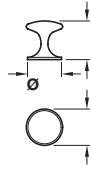



*Product is subject to variations in finish due to the finishing and manufacturing process of cer

CHLOEU knob

- > Order M4 handle screws separately
- > Brass
- > Order qty: 1 pc



	Cat. No.
	123.03.500
 Polished nickel	123.03.700

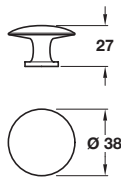



Note: ± 3 mm tolerance on non-critical dimensions

KEW knob

- > 1x M4 x 25 mm handle screw included
- > Brass
- > Order qty: 1 pc



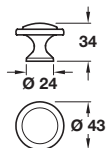

	Cat. No.
	134.97.482
 Stainless steel effect	134.97.083



CONSTANCE knob

- > Order M4 handle screws separately
- > Zinc alloy
- > Order qty: 1 pc



	Cat. No.
	134.45.220
 Stainless steel effect	134.45.620



Don't forget to order M4 handle screws, see page **353**

For our full range of fixing materials and installation tools see the Installation & Display section, pages **350-353**

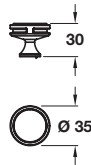

Oberon



OBERON knob

- > 1x 8/32 x 1" (non-metric) screw included
- > Zinc alloy
- > Order qty: 1 pc



	Cat. No.
 mpagne	133.50.618
 Polished nickel	133.50.622



All handles on this page include 8/32 x 1" (non-metric) screws. If you require a different length order non-metric cut off screw Cat. No. 022.24.881 shown on page **353**

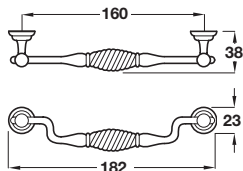

TWISTER drop handle

> 2x M4 x 26 mm handle screw included



Finish	Cat. No.
 Antique pewter	119.20.921

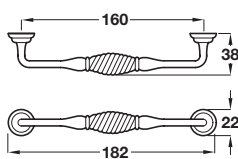

TWISTER D handle

> 2x M4 x 26 mm handle screw included
> Zinc alloy
> Order qty: 1 pc



Finish	Cat. No.
 Antique pewter	119.20.910

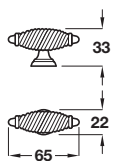

TWISTER pull handle

> 1x M4 x 26 mm handle screw included
> Zinc alloy
> Order qty: 1 pc



Finish	Cat. No.
 Antique pewter	119.20.900



TWISTER knob

> 1x M4 x 26 mm handle screw included
> Zinc alloy
> Order qty: 1 pc



Finish	Cat. No.
 Antique pewter	119.21.900

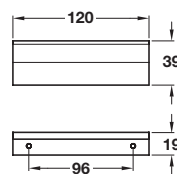
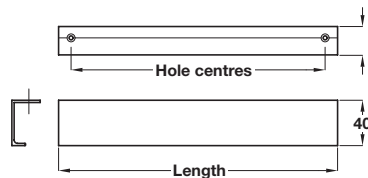
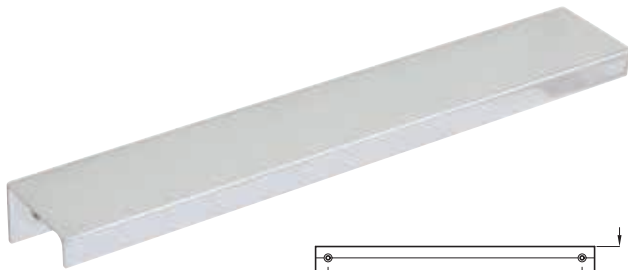
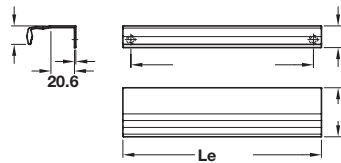
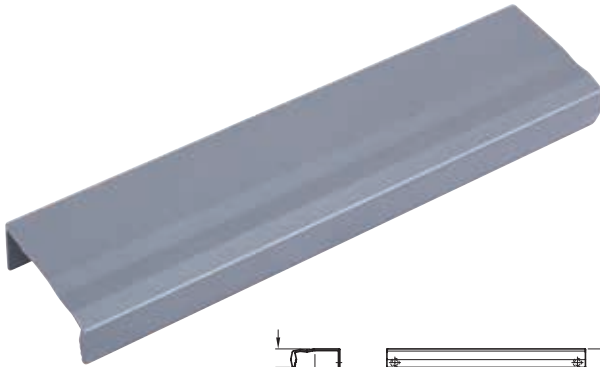

Note: ± 3 mm tolerance on non-critical dimensions and ±1 mm on hole centre dimensions

LINE profile handle

- > Order M4 handle screws separately
- > Aluminium
- > Order qty: 1 pc



	length	Hole centres	Cat. No.
● Matt anthracite	78 mm	64 mm	111.71.510
	174 mm	160 mm	111.71.511
	334 mm	320 mm	111.71.512

LISTER trim handle

- > Order screws separately
- > Aluminium
- > Order qty: 1 pc



		ntres	Cat. No.
● Brushed nickel	147 mm	128 mm	126.17.641
	297 mm	256 mm	126.17.642

RUBY trim handle

- > 2x Ø 3.0 x 13 mm countersunk head screws included
- > Brass
- > Order qty: 1 pc



	Cat. No.
●	112.84.024
●	112.84.724

Polished nickel

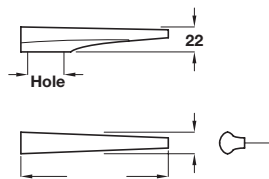

Fixings included

	Length	Hole centres	Cat. No.
Polished chrome	130 mm	32 mm	107.03.200
	210 mm	32/64 mm	107.03.201
	280 mm	64/96 mm	107.03.202

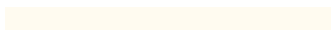

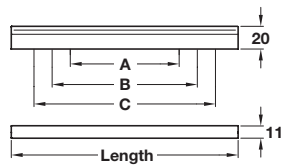

Angle



ANGLE pull handle

- > 2x M4 x 25 mm handle screws included
- > Aluminium
- > Order qty: 1 pc



					Cat. No.
					108.66.230
					108.66.231
					108.66.232
					108.66.234
					108.66.330
 Stainless steel effect	200 mm	96 mm	128 mm	160 mm	108.66.030

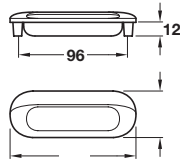

RHIN Inset handle

- > Order M4 handle screws separately
- > Zinc alloy
- > Order qty: 1 pc



	Cat. No.
Polished chrome / Aluminium coloured inside	151.17.209

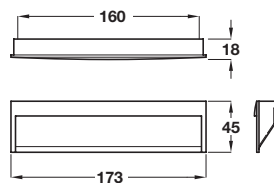
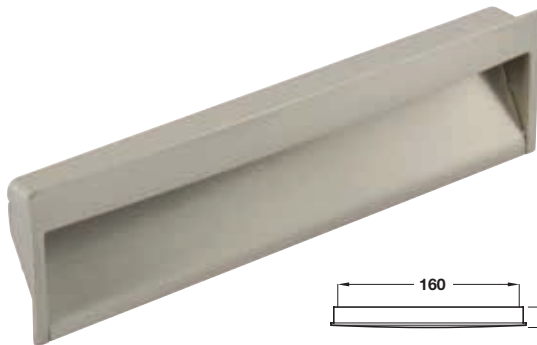

CAVENDISH inset handle

- > 2x M4 x 25 mm handle screws included
- > Zinc alloy
- > Order qty: 1 pc



	Cat. No.
Stainless steel effect	151.11.613

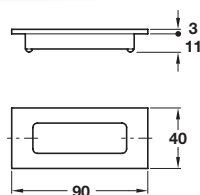

MAINE inset handle

- > Concealed fixing
- > 2x Ø 3.5 x 20 mm screws included
- > Brass
- > Order qty: 1 pc



	Cat. No.
Stainless steel effect	151.73.601

Cubic

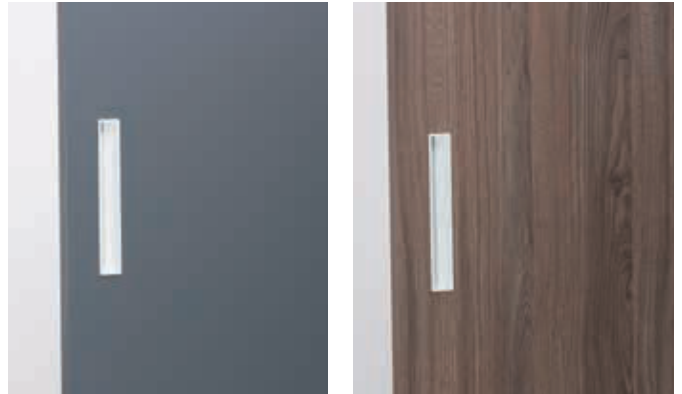

Matt white finish shown on both gloss dark grey or dark wood doors

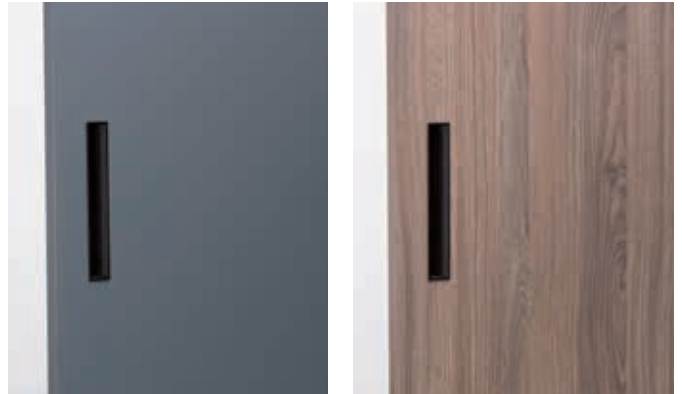

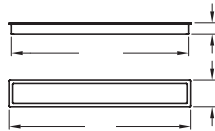

Matt black finish shown on both gloss dark grey or dark wood doors



CUBIC inset handle



> Press-in fixing

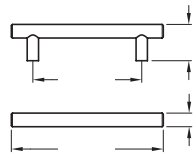

	Cat. No.
	151.11.640
 Matt black	151.11.641

Dimensional data not binding. We reserve the right to alter specifications without notice.





Don't forget to order M4 handle screws, see page **353**

For our full range of fixing materials and installation tools see the Installation & Display section, pages **350-353**

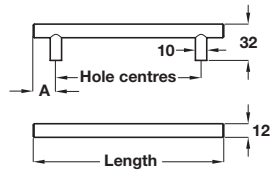

BARKSTON bar handle, Ø 12 mm

- > *2 each of M4 x 45 mm snap off handle screws included (101.20.700 includes an additional 1x M4 x 25 mm screw)
- > Order M4 handle screws separately
- > Steel
- > Order qty: 1 pc



		res	Dim. A	Cat. No.
 Stainless steel effect	136 mm	96 mm	20 mm	101.20.709
	168 mm	128 mm	20 mm	101.20.700*
	226 mm	156 mm	35 mm	101.20.701*
	230 mm	160 mm	35 mm	101.20.710*
	232 mm	192 mm	20 mm	101.20.708
	326 mm	256 mm	35 mm	101.20.702*
	376 mm	306 mm	35 mm	101.20.703*
	426 mm	356 mm	35 mm	101.20.704
	526 mm	456 mm	35 mm	101.20.705
	702 mm	632 mm	35 mm	101.20.706
828 mm	758 mm	35 mm	101.20.707*	

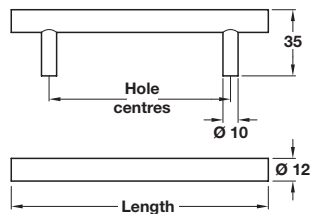



BELLA bar handle, Ø 12 mm

- > Order M4 handle screws separately
- > Steel
- > Order qty: 1 pc

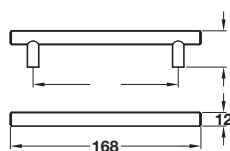

	ength	Hole centres	Cat. No.
 Polished chrome	136 mm	96 mm	117.97.224
	168 mm	128 mm	117.97.225
	200 mm	160 mm	117.97.218
	232 mm	192 mm	117.97.227
	328 mm	288 mm	117.97.219
	392 mm	352 mm	117.97.229



	No.
 Matt black epoxy	101.20.325

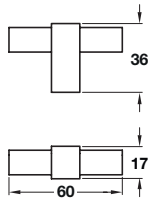

Tiberius



TIBERIUS bar handle

- > 2x M4 x 25 mm handle screws included
- > Aluminium



			at. No.
			2.85.050
			2.85.051
 Black nickel	195 mm	160 mm	112.85.071

TIBERIUS T knob

- > 1x M4 x 25 mm handle screw included
- > Aluminium
- > Order qty: 1 pc



	Cat. No.
 Black nickel	112.85.095

Carrione

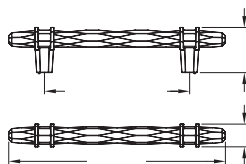

*Product is subject to variations in finish due to the finishing and manufacturing process of certain materials

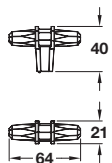

*Product is subject to variations in finish due to the finishing and manufacturing process of certain materials

CARRIONE pull handle

- > 2x 8/32 x 1" (non-metric) screws included
- > Zinc alloy
- > Order qty: 1 pc



	Length	Hole centres	Cat. No.
	160 mm	96 mm	133.53.035
	191 mm	128 mm	133.53.036
	160 mm	96 mm	133.53.037
	191 mm	128 mm	133.53.038



T knob

1" (non-metric) screw included

- > Zinc alloy
- > Order qty: 1 pc



	Cat. No.
polished nickel	133.53.033
Marble white / Oil rubbed bronze*	133.53.034



Dimensional data not binding. We reserve the right to alter specifications without notice.



All handles on this page include 8/32 x 1" (non-metric) screws. If you require a different length order non-metric cut off screw Cat. No. 022.24.881 shown on page **353**

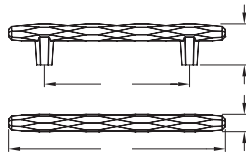

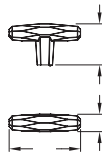

	133.50.639

Golden champagne



All handles on this page include 8/32 x 1" (non-metric) screws. If you require a different length order non-metric cut off screw Cat. No. 022.24.881 shown on page **353**

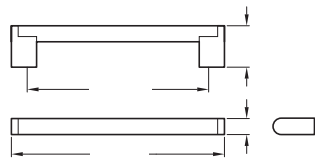
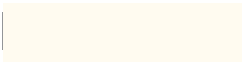

537 mm	509 mm	104.74.015
Solid steel bar		
751 mm	709 mm	104.74.016
849 mm	807 mm	104.74.017
951 mm	909 mm	104.74.018
1199 mm	1157 mm	104.74.019



Osaka

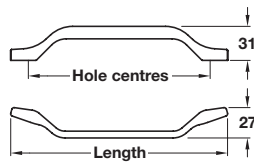

OSAKA pull handle

- > Fixings included:
 - Satin brass - 2x M4 x 50 mm snap-off handle screws
 - Antique copper and graphite - 2 each of M4 x 22 mm and M4 x 26 mm handle screws
- > Zinc alloy
- > Order qty: 1 pc



		entres	Cat. No.
●	mm	96 mm	110.22.080
	mm	160 mm	110.22.081
●	191 mm	160 mm	110.22.086
	351 mm	320 mm	110.22.089
● Graphite	191 mm	160 mm	110.22.586



Metropolis

The Metropolis range includes pull handles, bar handles and knobs in satin stainless steel

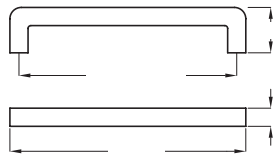

	ole centres		Cat. No.
Satin stainless steel	208 mm	192 mm	115.62.004
	336 mm	320 mm	115.62.008
	464 mm	448 mm	115.62.011

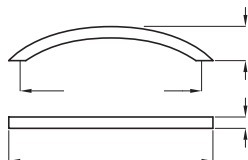

	ntres	Dim. A	Cat. No.	
Satin stainless steel	181 mm	160 mm	31 mm	100.55.003
	259 mm	224 mm	32 mm	100.55.005
	365 mm	320 mm	33 mm	100.55.008

METROPOLIS bow handle

> 2x M4 x 25 mm handle screws included



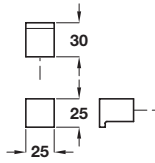

METROPOLIS knob

- > 1x M4 x 25 mm handle screw included
- > Grade 303 stainless steel
- > Order qty: 1 pc



	Size	Height	Cat. No.
	25 mm	30 mm	132.94.010

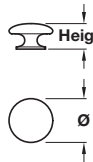

METROPOLIS knob

- > 1x M4 x 25 mm handle screw included
- > Grade 303 stainless steel
- > Order qty: 1 pc



	Diameter	Height	Cat. No.
	Ø 32 mm	30 mm	134.28.010
	Ø 38 mm	30 mm	132.94.040
	Ø 60 mm	35 mm	134.28.011

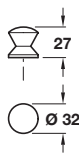

METROPOLIS knob

- > 1x M4 x 25 mm handle screw included
- > Grade 303 stainless steel
- > Order qty: 1 pc



	Diameter	Height	Cat. No.
	Ø 32 mm	27 mm	134.28.020



Knob

Backplate

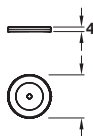
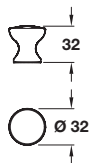

METROPOLIS knob and backplate

- > 1x M4 x 25 mm handle screw included
- > Grade 303 stainless steel
- > Order qty: 1 pc



	Item	Cat. No.
	Knob	132.94.030
	Backplate	132.94.090



Use with or without backplate.
Order backplate separately

Oasi

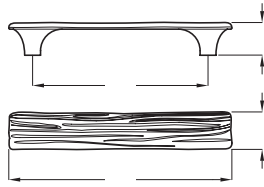

OASI bar handle

> Order M4 handle screws separately



	Cat. No.
 Polished chrome	116.60.213

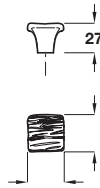

> Order M4 handle screws separately
 > Zinc alloy
 > Order qty: 1 pc



	Cat. No.
 Polished chrome	131.27.260



page **353**

Installation tools see the Installation & Display section, pages **350-353**

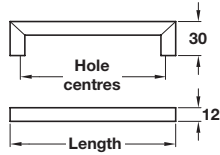

BALTIMORE D handle

- > Order M4 handle screws separately
- > Zinc alloy
- > Order qty: 1 pc



		ntres	Cat. No.
Polished chrome	114 mm	96 mm	102.12.201
	146 mm	128 mm	102.12.202

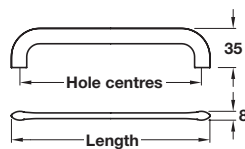
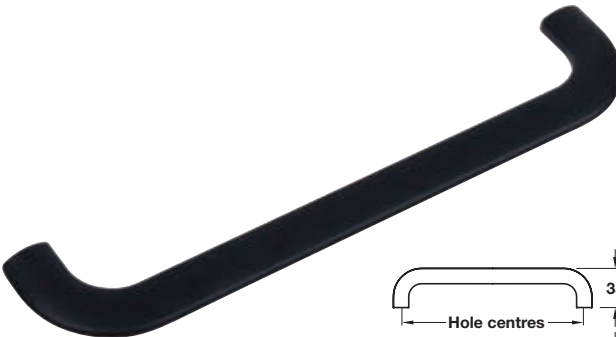

			Cat. No.
Matt black	79 mm	64 mm	111.71.010
	175 mm	160 mm	111.71.011
	335 mm	320 mm	111.71.012

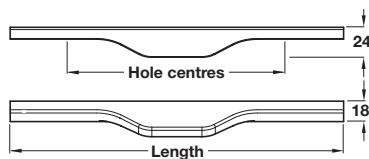

Product is subject to variations in colour and dimensions due to being manufactured from natural materials

ULTRA pull handle

- > Order M4 handle screws separately
- > Ash
- > Order qty: 1 pc



		Hole centres	Cat. No.
Oak lacquered	294 mm	192 mm	193.18.417
	394 mm	256 mm	193.18.418
	594 mm	160/480 mm	193.18.419

Graf & Graf 2

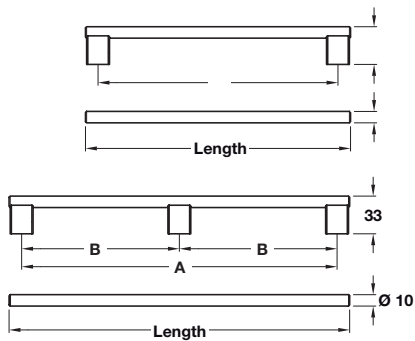
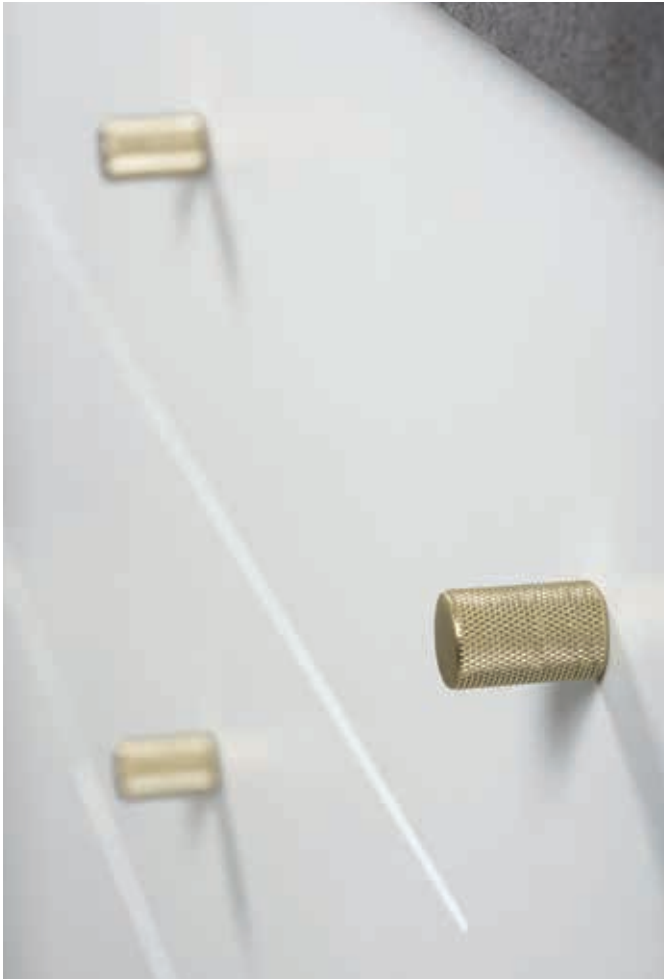

AF 2 bar handle

3x M4 x 25 mm handle screws included



actions without notice.



	182 mm	160 mm	-	132.19.120
	278 mm	256 mm	-	132.19.121
	1200 mm	1178 mm	589 mm	132.19.122

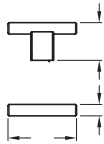

GRAF 2 T knob

- > 1x M4 x 25 mm handle screw included
- > Aluminium
- > Order qty: 1 pc



	Cat. No.
	132.19.105
	132.19.106
Brushed dark brass	132.19.107

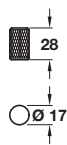

GRAF knob

- > 1x M4 x 25 mm handle screw included
- > Aluminium
- > Order qty: 1 pc



Finish	Cat. No.
Polished chrome	132.15.230
Brushed brass	132.19.210
Matt black	132.19.211
Stainless steel effect	132.15.630
Brushed dark brass	106.60.318

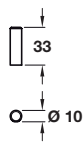

GRAF 2 cylindrical knob

- > 1x M4 x 25 mm handle screw included
- > Aluminium
- > Order qty: 1 pc



	Cat. No.
effect	132.19.100
	132.19.101
Brushed dark brass	132.19.102

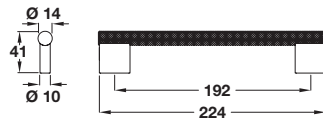

	No.
	112
	.110
Brushed dark brass	106.66.111

GRAF BIG knob

- > 1x M4 x 25 mm handle screw included
- > Aluminium
- > Order qty: 1 pc



Finish	Ø 38 mm	Ø 50 mm
Stainless steel effect	106.66.102	106.66.105
shed black	106.66.100	106.66.103
Dark brass	106.66.101	106.66.104



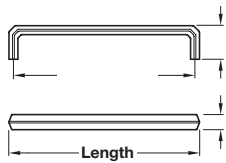
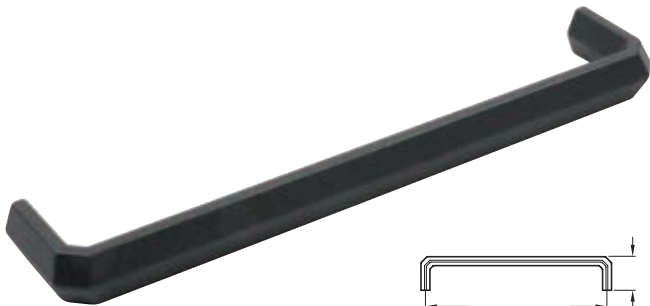
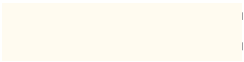

<input checked="" type="checkbox"/>			
<input type="checkbox"/>			
<input type="checkbox"/>			
<input checked="" type="checkbox"/>	Matt black	168 mm	160 mm
			113.96.121

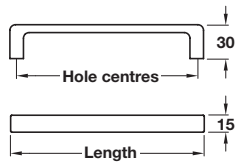

<input checked="" type="checkbox"/>			
<input type="checkbox"/>			
<input type="checkbox"/>			
<input checked="" type="checkbox"/>	Matt black	172 mm	160 mm
		332 mm	320 mm
			113.96.100
			113.96.101

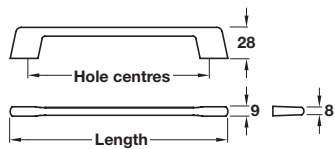

<input checked="" type="checkbox"/>			
<input type="checkbox"/>			
<input type="checkbox"/>			
<input checked="" type="checkbox"/>	Matt black	153 mm	128 mm
		185 mm	160 mm
			113.96.110
			113.96.111



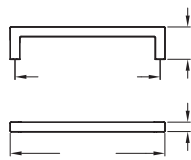
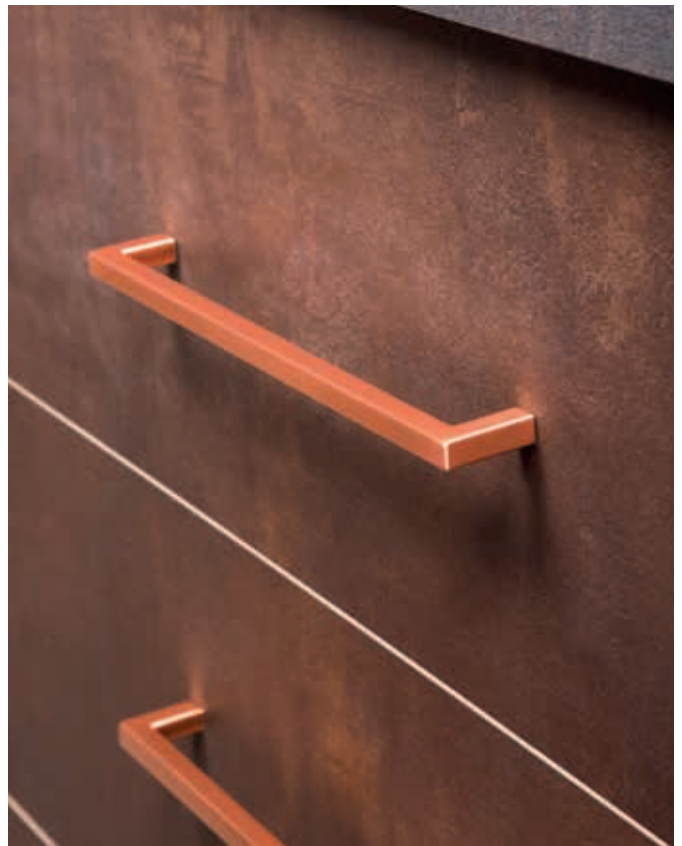

2x M4 x 25 mm handle screws included
 Zinc alloy
 Order qty: 1 pc



●			
●			6.285
			6.380
			6.286
			6.287
●			6.388
			6.389
			6.390
			6.391
●	136.5 mm	128 mm	108.66.376
Brushed copper	200.5 mm	192 mm	108.66.377
	328.5 mm	320 mm	108.66.378
	500.5 mm	492 mm	108.66.379



ESTE pull handle



<input checked="" type="checkbox"/>		
<input type="checkbox"/>		
<input type="checkbox"/>		
<input type="checkbox"/>		5
<input type="checkbox"/>	Brushed copper	108.66.455

➔ The COMO knob shown on page **323** matches the ESTE pull handle

Burbridge

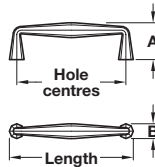

*Product is subject to variations in finish due to the finishing and manufacturing process of certain materials

BRIDGE pull handle



- > 2x M4 x 25 mm handle screws included
- > Brass or cast iron
- > Order qty: 1 pc



		e _s	Dim. A	Dim. B	Cat. No.
		m	35 mm	15 mm	116.35.745
		m	37 mm	15 mm	116.35.746
		mm	35 mm	15 mm	116.35.545
		mm	35 mm	15 mm	116.35.945
	109 mm	96 mm	33 mm	13 mm	116.35.344
	212 mm	192 mm	40 mm	17 mm	116.35.347

BURBRIDGE knob



- > 1x M4 x 25 mm handle screw included
- > Brass
- > Order qty: 1 pc

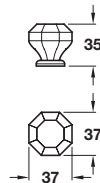

*Product is subject to variations in finish due to the finishing and manufacturing process of certain materials

	Cat. No.
ss*	123.03.510
Polished nickel	123.03.710

Dimensional data not binding. We reserve the right to alter specifications without notice.

Brera

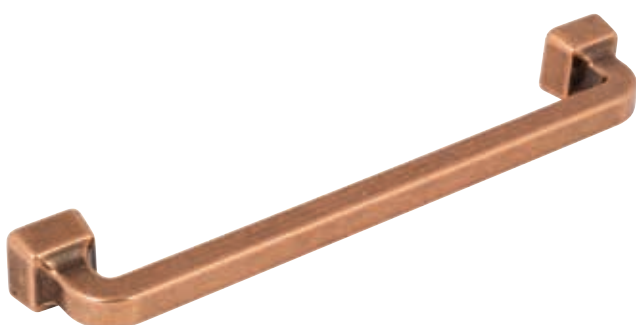

BRERA D handle

- > Order M4 handle screws separately
- > Zinc alloy

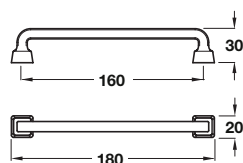

	.22.274
	.22.275
 Pewter	110.22.276





Dimensional data not binding. We reserve the right to alter specifications without notice.



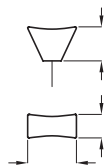
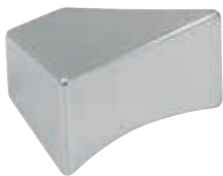
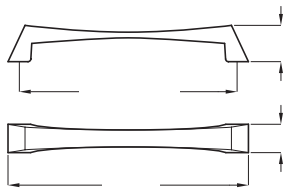

page **353**
Installation tools see the Installation & Display section, pages **350-353**

Caleido





	effect	131.10.620
	Polished chrome	131.10.220



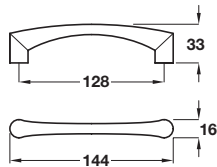

EMERSON D handle

> 2x M4 x 45 mm snap off handle screws included



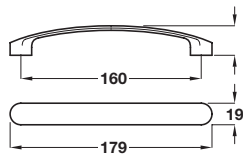

	Cat. No.
 Matt nickel	101.71.022



HARRINGTON D handle

> 2x M4 x 45 mm snap off handle screws included
 > Zinc alloy
 > Order qty: 1 pc



	Cat. No.
	111.85.223
 Stainless steel effect	111.85.023

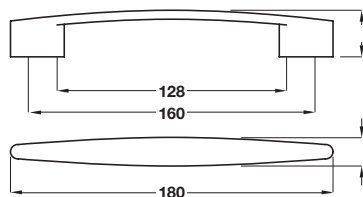

MONTROSE D pull handle

> Order M4 handle screws separately
 > Zinc alloy
 > Order qty: 1 pc



	Cat. No.
 Polished chrome	110.34.236



Don't forget to order M4 handle screws, see page **353**
 For our full range of fixing materials and installation tools see the Installation & Display section, pages **350-353**

Crystal

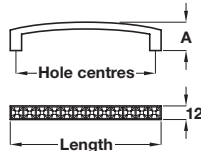

CRYSTAL D handle

- > Order M4 handle screws separately
- > Made with CRYSTALLIZED™ Swarovski Elements
- > Zinc alloy



				. No.
	107 mm	96 mm	22 mm	103.29.221
	140 mm	128 mm	25 mm	103.29.222

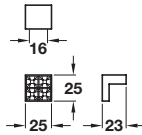

CRYSTAL pull handle

- > Order M4 handle screws separately
- > Made with CRYSTALLIZED™ Swarovski Elements
- > Zinc alloy
- > Order qty: 1 pc



	Cat. No.
Polished chrome	132.19.240

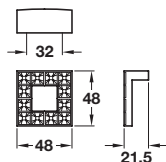

CRYSTAL pull handle

- > 2x M4 x 25 mm handle screws included
- > Made with CRYSTALLIZED™ Swarovski Elements
- > Zinc alloy
- > Order qty: 1 pc



	Cat. No.
Polished chrome	132.19.220

Glacio

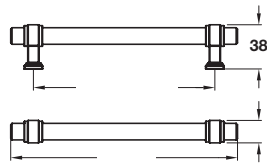

GLACIO pull handle

- > 2x 8/32 x 1" (non-metric) screws included
- > Zinc/Glass
- > Order qty: 1 pc



	Length	Hole centres	Cat. No.
 Polished nickel / Clear	167 mm	128 mm	133.53.039
	200 mm	160 mm	133.53.040

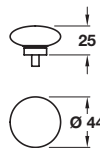

GLACIO knob

- > 1x 8/32 x 1" (non-metric) screw included
- > Zinc/Glass
- > Order qty: 1 pc



Finish	Cat. No.
 Polished nickel / Clear	133.50.122

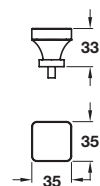

GLACIO square knob

- > 1x 8/32 x 1" (non-metric) screw included
- > Zinc/Glass
- > Order qty: 1 pc



Finish	Cat. No.
 Polished nickel / Clear	133.50.120

Dimensional data not binding. We reserve the right to alter specifications without notice.

➔ All handles on this page include 8/32 x 1" (non-metric) screw Cat. No. 022.24.881 shown on page **353**

re a different length order non-metric cut off

Byron

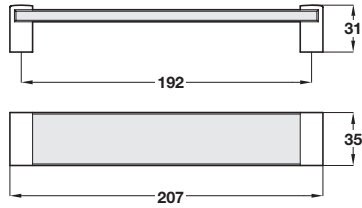

BYRON bar handle

- > 2x M4 x 25 mm handle screws included
- > Zinc alloy, with tempered glass



 Polished chrome with clear glass	108.80.507

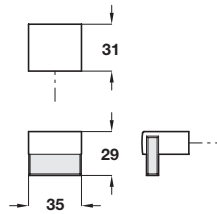

BYRON knob

- > 1x M4 x 25 mm handle screw included
- > Zinc alloy, with tempered glass
- > Order qty: 1 pc



	Cat. No.
 Polished chrome with clear glass	131.14.200

Dimple

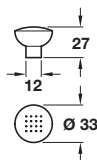
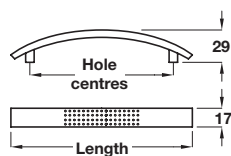

DIMPLE bow handle

- > Order M4 handle screws separately
- > Zinc alloy



		Hole centres	Cat. No.
		96 mm	101.69.201
		128 mm	101.69.202
		96 mm	101.69.601
		128 mm	101.69.602
	126 mm	96 mm	101.69.001
	158 mm	128 mm	101.69.002

DIMPLE knob

- > Order M4 handle screws separately
- > *1x M4 x 25 mm screw included
- > Zinc alloy



	Cat. No.
	135.48.202
	135.48.402
	135.48.002*

Dimensional data not binding. We reserve the right to alter specifications without notice.

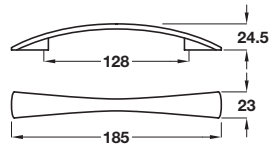

QUIGLEY bow handle

- > Order M4 handle screws separately
- > Zinc alloy



	Cat. No.
	109.29.202
	109.29.602
Aluminium coloured	109.29.402

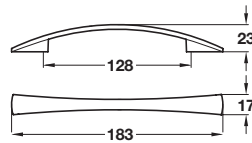

OCTAVIA lightweight bow handle

- > Order M4 handle screws separately
- > Zinc alloy
- > Order qty: 1 pc



	No.
	102.33.605
Polished chrome	102.33.205

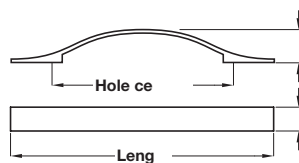

CHISWICK bow handle

- > Order M4 handle screws separately
- > Zinc alloy



	No.
	108.89.243
Stainless steel effect	108.89.043



Don't forget to order M4 handle screw
For our full range of fixing materials and installation tools see the Installation & Display section, pages **350-353**

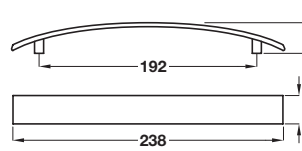

CICERO bow handle

- > Order M4 handle screws separately
- > Zinc alloy
- > Order qty: 1 pc



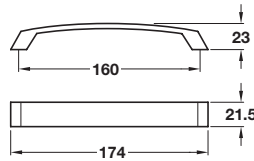

	Cat. No.
 Stainless steel effect	102.35.034



TAVISTOCK bow handle

- > 2 each of M4 x 22 mm and M4 x 25 mm handle screws included
- > *2x M4 x 45 mm snap off handle screws included
- > Aluminium



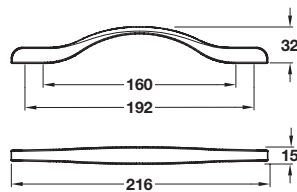

	No.
	226
 Stainless steel effect	109.53.626*



HENLEY bow handle

- > Order M4 handle screws separately
- > Zinc alloy
- > Order qty: 1 pc



	Cat. No.
	108.89.116
 Graphite	108.89.516



& Display section, pages 350-353

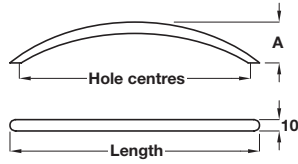

INDIGO bow handle

- > Order M4 handle screws separately
- > Steel
- > Order qty: 1 pc



		Hole centres	Dim. A	Cat. No.	
			30 mm	117.31.222	
		m	30 mm	117.31.231	
		m	32 mm	117.31.241	
		m	32 mm	117.31.261	
	Matt black	151 mm	128 mm	30 mm	106.43.302
		187 mm	160 mm	32 mm	106.43.303

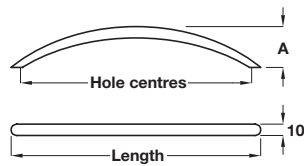

Bow handle

- > Order M4 handle screws separately



			im. A	Cat. No.	
			4 mm	106.43.401	
			0 mm	106.43.402	
			2 mm	106.43.403	
			0 mm	106.43.407	
	Polished brass	118 mm	96 mm	24 mm	106.43.801
		151 mm	128 mm	30 mm	106.43.802
		187 mm	160 mm	32 mm	106.43.803
		320 mm	288 mm	40 mm	106.43.807

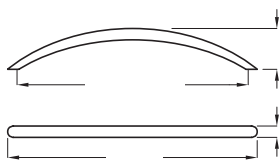

CLIFTON bow handle

- > Order M4 handle screws separately
- > *2x M4 handle screws included



			Dim. A	Cat. No.	
	Brushed stainless steel effect	111 mm	96 mm	30 mm	117.31.021
		148 mm	128 mm	30 mm	117.31.031*
		184 mm	160 mm	32 mm	117.31.041
		221 mm	192 mm	32 mm	117.31.052
		258 mm	224 mm	32 mm	117.31.053
		332 mm	288 mm	32 mm	117.31.071

Hudson

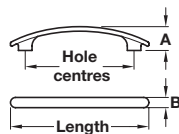

HUDSON bow handle

- > 2x M4 x 45 mm snap off screws included
- > Zinc alloy
- > Order qty: 1 pc



			Dim. A	Cat. No.
Polished chrome	90 mm	64 mm	19 mm	102.34.210
	123 mm	96 mm	21 mm	102.34.211
	157 mm	128 mm	22 mm	102.34.212
	190 mm	160 mm	24 mm	102.34.213
	256 mm	224 mm	27 mm	102.34.215
	320 mm	288 mm	33 mm	102.34.217

Cordelia

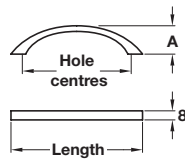

CORDELIA bow handle

- > Order M4 handle screws separately
- > Zinc alloy



		res	Dim. A	Cat. No.
 Polished chrome	86.5 mm	64 mm	19 mm	107.66.210
	150 mm	128 mm	31 mm	107.66.212
	186 mm	160 mm	31.5 mm	107.66.213
	318 mm	288 mm	38.5 mm	107.66.217



Don't forget to order M4 handle screws, see page **353**
 For our full range of fixing materials and installation tools see the Installation & Display section, pages **350-353**

Henrietta

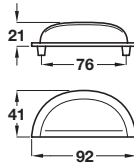

The MAYBERRY knob shown on page **133** also matches the HENRIETTA cup handle

HENRIETTA cup handle

- > 2x M4 x 25 mm and 2x M4 x 45 mm snap off handle screws included
- > *Order M4 handle screws separately
- > Zinc alloy
- > Order qty: 1 pc



	Cat. No.
	166.11.204*
	166.11.400*
Polished black nickel	166.11.305

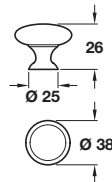

HENRIETTA knob

- > 1x M4 x 25 mm handle screw included
- > Zinc alloy
- > Order qty: 1 pc



Finish	Cat. No.
ed chrome	134.39.210
Stainless steel effect	134.39.020

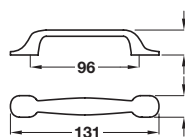

HENRIETTA D handle

- > 2x M4 x 25 mm handles screws and 2x M4 x 45 mm snap off handle screws included
- > *Order fixing screws separately
- > Aluminium



	Cat. No.
	109.48.224
Stainless steel effect	118.53.600*



Ariel

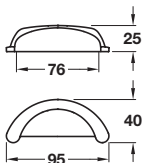

ARIEL cup handle

- > 2 each of M4 x 20 mm, 22 mm and 27 mm handle screws included
- > *Order fixing screws separately for polished chrome finish
- > Zinc alloy
- > Order qty: 1 pc



	Cat. No.
	166.11.240*
Pewter effect	166.11.905

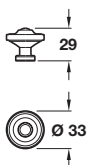

ARIEL knob

- > 1 each of M4 x 22 mm and 27 mm handle screws included
- > *Order fixing screws separately for polished chrome finish
- > Zinc alloy
- > Order qty: 1 pc



	Cat. No.
Polished chrome	134.06.200*
Pewter effect	166.11.900



Don't forget to order M4 handle screws, see page **353**
For our full range of fixing materials and installation tools see the Installation & Display section, pages **350-353**

Odessa

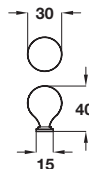
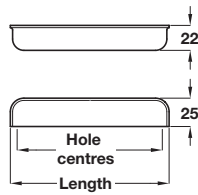

ODESSA cup handle

- > Order M4 handle screws separately
- > Zinc alloy
- > Order qty: 1 pc



	Length	Hole centres	Cat. No.
me	78 mm	64 mm	151.40.660
	140 mm	128 mm	151.40.665
effect	78 mm	64 mm	151.40.661
	140 mm	128 mm	151.40.666
Brushed copper	78 mm	64 mm	151.40.662
	140 mm	128 mm	151.40.667

ODESSA knob

- > Order M4 handle screws separately
- > Zinc alloy
- > Order qty: 1 pc



Finish	Cat. No.
Polished chrome	110.35.360
Stainless steel effect	110.35.361
Brushed copper	110.35.362



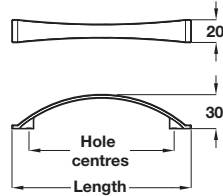

ODESSA bow handle

- > Order M4 handle screws separately
- > Zinc alloy
- > Order qty: 1 pc



	Hole centres	Cat. No.
	128 mm	107.03.610
		107.03.611
 Brushed copper		107.03.613

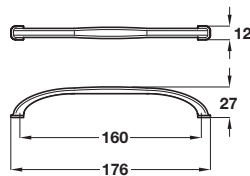

ODESSA bow handle

- > Order M4 handle screws separately
- > Zinc alloy



	Cat. No.
	107.03.615
	107.03.616
 Brushed copper	107.03.617



Don't forget to order M4 handle screws, see page **353**
 For our full range of fixing materials and installation tools see the Installation & Display section, pages **350-353**

Delia

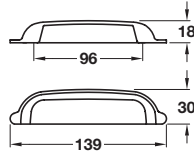

*Product is subject to variations in finish due to the finishing and manufacturing process of certain materials

DELIA cup handle

- > Order M4 handle screws separately
- > Brass
- > Order qty: 1 pc



	Cat. No.
	110.35.115
	110.35.116
Antique copper*	110.35.117

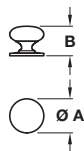

*Product is subject to variations in finish due to the finishing and manufacturing process of certain materials

DELIA knob

- > Order M4 handle screw separately
- > Brass
- > Order qty: 1 pc



Finish	Dim. A	Dim. B	Cat. No.
ss*	Ø 30 mm	26 mm	110.35.110
	Ø 35 mm	28 mm	110.35.105
Polished nickel	Ø 30 mm	26 mm	110.35.111
	Ø 35 mm	28 mm	110.35.106
Antique copper*	Ø 30 mm	26 mm	110.35.112
	Ø 35 mm	28 mm	110.35.107

Jude

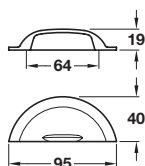



*Product is subject to variations in finish due to the finishing and manufacturing process of certain materials

JUDE cup handle

- > Order M4 handle screws separately
- > Brass
- > Order qty: 1 pc



	Cat. No.
 Brushed brass*	110.35.120
 Polished nickel	110.35.121
 Antique copper*	110.35.122

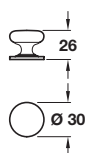



*Product is subject to variations in finish due to the finishing and manufacturing process of certain materials

JUDE knob

- > Order M4 handle screw separately
- > Brass
- > Order qty: 1 pc



Finish	Cat. No.
 Brushed brass*	110.35.100
 Polished nickel	110.35.101
 Antique copper*	110.35.102

Mulberry

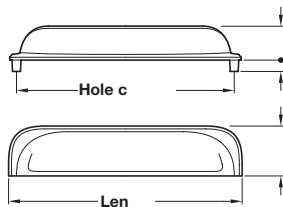



Note: ± 3 mm tolerance on non-critical dimensions and

MULBERRY cup handle

- > Order M4 handle screws separately
- > *2x M4 x 25 mm handle screws included
- > Brass
- > Order qty: 1 pc



		Hole centres	Cat. No.
 Polished nickel	77 mm	64 mm	151.40.203*
	108 mm	96 mm	151.40.204*
	204 mm	192 mm	151.40.207*
 chrome	108 mm	96 mm	151.40.254
 Brushed copper	108 mm	96 mm	151.40.154



Don't forget to order M4 handle screws, see page **353**

For our full range of fixing materials and installation tools see the Installation & Display section, pages **350-353**

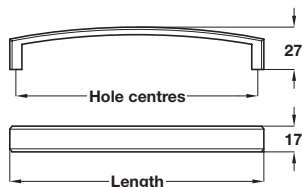

Note: ± 3 mm tolerance on non-critical dimensions and ±1 mm on hole centre dimensions

MULBERRY D handle

> 2x M4 x 25 mm handle screws included



		Hole centres	Cat. No.	
	Polished nickel	135 mm	128 mm	116.35.255
		168 mm	160 mm	116.35.256

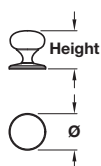

Note: ± 3 mm tolerance on non-critical dimensions

MULBERRY knob

- > Order M4 handle screws separately
- > *1x M4 x 25 mm handle screw included
- > Brass
- > Order qty: 1 pc



	Diameter	Height	Cat. No.	
	nickel	Ø 32 mm	36 mm	123.02.700*
		Ø 38 mm	42 mm	123.02.710*
	chrome	Ø 38 mm	42 mm	134.97.220
	Brushed copper	Ø 38 mm	42 mm	134.97.020

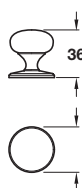

Note: ± 3 mm tolerance on non-critical dimensions and ±1 mm on hole centre d

MULBERRY knob

- > 1x M4 x 25 mm handle screw included
- > Brass
- > Order qty: 1 pc



	Cat. No.
chrome	135.07.230
Stainless steel effect	135.07.600

Kane

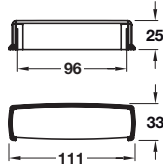

Product is subject to variations in finish due to the finishing and manufacturing process of certain materials

KANE cup handle

- > 2x 8/32 x 1" (non-metric) screws included
- > Zinc alloy
- > Order qty: 1 pc



	Cat. No.
 Oil rubbed bronze	133.50.140

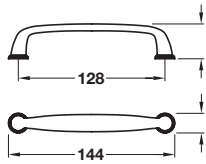

Product is subject to variations in finish due to the finishing and manufacturing process of certain m

KANE pull handle



	at. No.
 Oil rubbed bronze	133.50.340

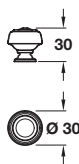

Product is subject to variations in finish due to the finishing and manufacturing process of certain materials

KANE knob

- > 1x 8/32 x 1" (non-metric) screw included
- > Zinc alloy
- > Order qty: 1 pc



Finish	Cat. No.
 Oil rubbed bronze	133.50.609



All handles on this page include 8/32 x 1" (non-metric) screws. If you require a different length order non-metric cut off screw Cat. No. 022.24.881 shown on page 353

Crawford

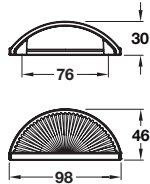



*Product is subject to variations in finish due to the finishing and manufacturing process of certain materials

CRAWFORD cup handle

- > 2x 8/32 x 1" (non-metric) screws included
- > Zinc alloy
- > Order qty: 1 pc



Finish	Cat. No.
 Golden champagne	133.50.143
 Oil rubbed bronze*	133.50.144

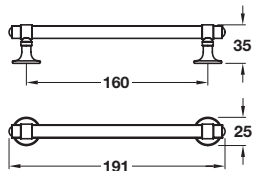
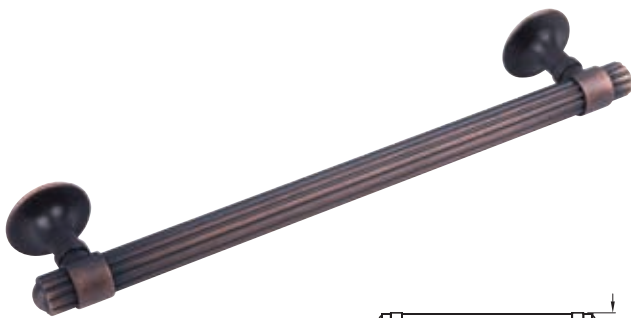



*Product is subject to variations in finish due to the finishing and manufacturing process of certain materials

CRAWFORD pull handle

- > 2x 8/32 x 1" (non-metric) screws included
- > Zinc alloy
- > Order qty: 1 pc



Finish	Cat. No.
 Champagne	133.50.374
 Oil rubbed bronze*	133.50.377

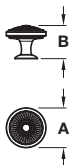



*Product is subject to variations in finish due to the finishing and manufacturing process of certain materials

CRAWFORD knob

- > 1x 8/32 x 1" (non-metric) screw included
- > Zinc alloy
- > Order qty: 1 pc



Finish	Dim. A	Dim. B	Cat. No.
 Golden champagne	Ø 35 mm	30 mm	133.50.303
 Oil rubbed bronze*	Ø 35 mm	30 mm	133.50.305



EGG TIMER knob

- > 1x M4 x 30 mm handle screw and 2x washers included
- > Aluminium
- > Order qty: 1 pc

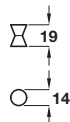



	Cat. No.
 Polished nickel	133.99.601

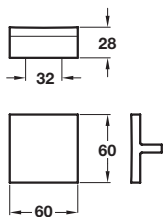

AMBER knob

- > Order M4 handle screws separately
- > Zinc alloy
- > Order qty: 1 pc



	Cat. No.
 Polished chrome	131.14.260



JUPITER knob

- > 1x M4 x 25 mm handle screw included
- > Brass
- > Order qty: 1 pc

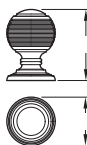

Note: ± 3 mm tolerance on non-critical dimensions and

	Diameter	Height	Cat. No.
 Stainless steel effect	Ø 32 mm	44 mm	123.02.080
	Ø 38 mm	52 mm	135.07.610



Don't forget to order M4 handle screws, see page **353**
For our full range of fixing materials and installation tools see the Installation & Display section, pages **350-353**

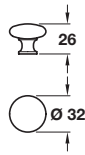

ORIEL knob

- > Order M4 handle screws separately
- > Zinc alloy
- > Order qty: 1 pc



	Cat. No.
	134.02.600
	135.24.600
Polished chrome	133.09.200

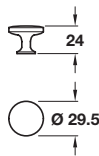

CASSIUS knob

- > Order M4 handle screws separately
- > Zinc alloy
- > Order qty: 1 pc



	Cat. No.
Stainless steel effect	137.35.600

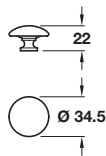

AMELIA knob

- > 1x M4 x 25 mm handle screw included
- > *Order M4 handle screws separately
- > Zinc alloy
- > Order qty: 1 pc



	Cat. No.
	135.00.600
	133.10.600*
Polished chrome	133.10.200*

Rocher & Balley

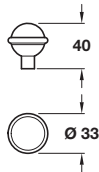

Note: ± 3 mm tolerance on non-critical dimensions

- > 1x M4 x 25 mm handle screw included
- > Brass
- > Order qty: 1 pc



	Cat. No.
 Polished nickel	137.80.730

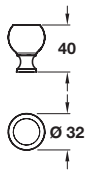

BALLEY knob

- > 1x M4 x 25 mm handle screw included
- > Brass
- > Order qty: 1 pc



	Cat. No.
 Polished nickel	135.07.720



SULA knob shown on page **164** also available



Rocher knob Cat. No. 137.80.730 shown on round backplate Cat. No. 137.80.740

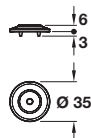

Note: ± 3 mm tolerance on non-critical dimensions

Round backplate

- > Order M4 handle screw separately
- > Brass
- > Order qty: 1 pc



	Cat. No.
 Polished nickel	137.80.740

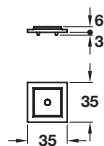

Note: ± 3 mm tolerance on non-critical dimensions

Square backplate

- > Order M4 handle screw separately
- > Brass
- > Order qty: 1 pc



	Cat. No.
 Polished nickel	137.80.750

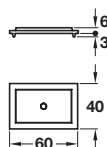

Note: ± 3 mm tolerance on non-critical dimensions

Rectangular backplate

- > Order M4 handle screw separately
- > Brass
- > Order qty: 1 pc



	Cat. No.
 Polished nickel	137.80.760

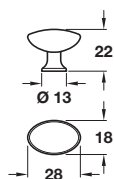
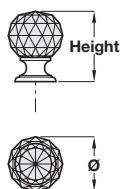

HARLEY knob

- > 1x M4 x 22 mm and 1x M4 x 25 mm handle screws included
- > Glass knob with brass base
- > Order qty: 1 pc





	gth	Height	Cat. No.
	Ø 30 mm	41 mm	139.60.422
	Ø 35 mm	45 mm	139.60.423

PEARL knob

- > Order M4 handle screws separately
- > Zinc alloy
- > Order qty: 1 pc



	Cat. No.
 chrome	133.09.210
 el	133.09.410
 Brushed copper	133.09.010



Como



➔ The ESTE pull handle shown on page 293 matches the COMO knob

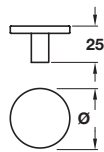

COMO knob

- > 1x M4 x 25 mm handle screw included
- > Zinc alloy
- > Order qty: 1 pc



	Cat. No.
	106.66.287
	106.66.285
	106.66.284
 Brushed copper	106.66.286

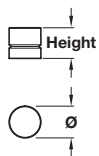

ACER knob

- > 1x M4 x 25 mm handle screw included
- > Stainless steel
- > Order qty: 1 pc



	iameter	Height	Cat. No.
	Ø 18 mm	23 mm	134.88.611
Stainless steel	Ø 28 mm	27 mm	134.88.610

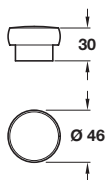

ACACIA knob

- > Order M4 handle screws separately
- > Zinc alloy
- > Order qty: 1 pc



	Cat. No.
 Stainless steel effect	131.15.000



Don't forget to order M4 handle screws, see page **353**

For our full range of fixing materials and installation tools see the Installation & Display section, pages **350-353**

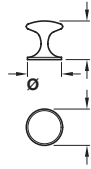

*Product is subject to variations in finish due to the finishing and manufacturing process of cer

CHLOEU knob

- > Order M4 handle screws separately
- > Brass
- > Order qty: 1 pc



	Cat. No.
	123.03.500
Polished nickel	123.03.700

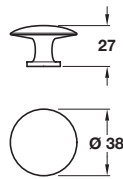

Note: ± 3 mm tolerance on non-critical dimensions

KEW knob

- > 1x M4 x 25 mm handle screw included
- > Brass
- > Order qty: 1 pc



	Cat. No.
	134.97.482
Stainless steel effect	134.97.083

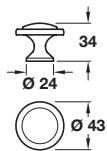

CONSTANCE knob

- > Order M4 handle screws separately
- > Zinc alloy
- > Order qty: 1 pc



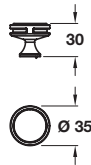

	Cat. No.
	134.45.220
Stainless steel effect	134.45.620

Oberon



- > 1x 8/32 x 1" (non-metric) screw included
- > Zinc alloy
- > Order qty: 1 pc



	Cat. No.
 mpagne	133.50.618
 Polished nickel	133.50.622



All handles on this page include 8/32 x 1" (non-metric) screws. If you require a different length order non-metric cut off screw Cat. No. 022.24.881 shown on page **353**

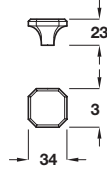

CORBUSIER knob

- > 1x M4 handle screw included
- > Zinc alloy
- > Order qty: 1 pc



	Cat. No.
 Polished chrome	123.08.260

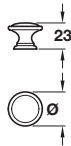

ANGUS knob

- > Order M4 handle screws separately
- > Zinc alloy
- > Order qty: 1 pc



	Cat. No.
	118.06.214
	118.06.616
 Antique brass	118.06.116



Don't forget to order M4 handle screws, see page **353**
 For our full range of fixing materials and installation tools see the Installation & Display section, pages **350-353**

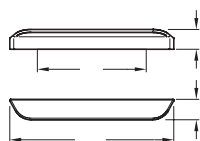
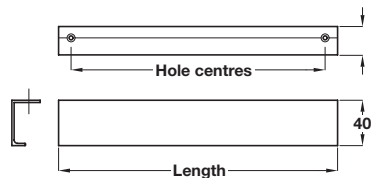
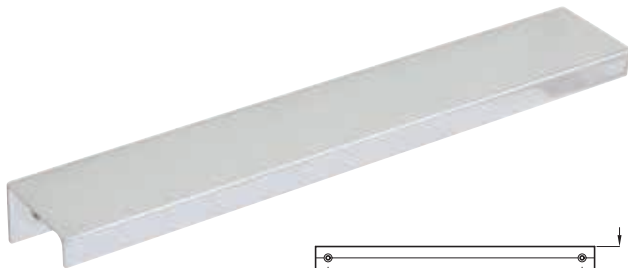
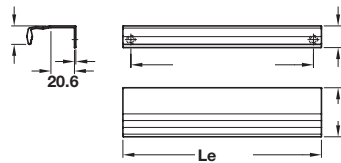
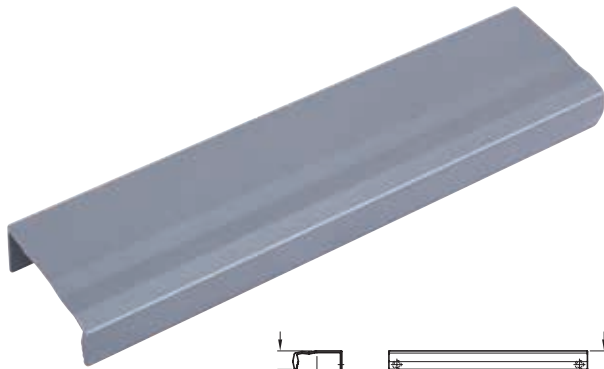

LINE profile handle

- > Order M4 handle screws separately
- > Aluminium
- > Order qty: 1 pc



	length	Hole centres	Cat. No.
● Matt anthracite	78 mm	64 mm	111.71.510
	174 mm	160 mm	111.71.511
	334 mm	320 mm	111.71.512

LISTER trim handle

- > Order screws separately
- > Aluminium
- > Order qty: 1 pc



		ntres	Cat. No.
● Brushed nickel	147 mm	128 mm	126.17.641
	297 mm	256 mm	126.17.642

OXFORD pull handle

- > 2x M4 x 25 mm handle screws and 2x M4 x 45 mm snap off handle screws included
- > Zinc alloy
- > Order qty: 1 pc



	Cat. No.
● Polished chrome	102.18.224



Don't forget to order M4 handle screws, see page **353**

For our full range of fixing materials and installation tools see the Installation & Display section, pages **350-353**

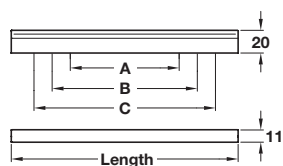

Angle



ANGLE pull handle

- > 2x M4 x 25 mm handle screws included
- > Aluminium
- > Order qty: 1 pc



					Cat. No.
					108.66.230
					108.66.231
					108.66.232
					108.66.234
					108.66.330
 Stainless steel effect	200 mm	96 mm	128 mm	160 mm	108.66.030

Dimensional data not binding. We reserve the right to alter specifications without notice.

Nick

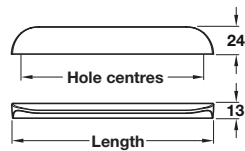

NICK pull handle

- > 2x M4 x 25 mm handle screws included
- > Aluminium
- > Order qty: 1 pc



	Length	Hole centres	Cat. No.
	50 mm	32 mm	126.45.060
	178 mm	160 mm	126.45.061
	50 mm	32 mm	126.45.062
	178 mm	160 mm	126.45.063



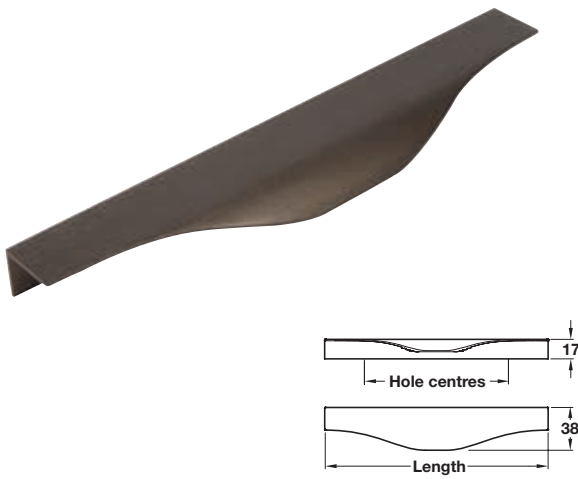

NOMA profile handle

- > 2x M4 x 15 mm handle screws included
- > Aluminium
- > Order qty: 1 pc



	gth	Hole centres	Cat. No.
	mm	128 mm	126.45.045
	mm	256 mm	126.45.048
	200 mm	128 mm	126.45.965
	350 mm	256 mm	126.45.969
	200 mm	128 mm	126.45.046
	350 mm	256 mm	126.45.049

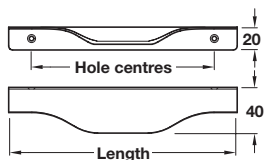

PATIENCE profile handle

- > Order M4 handle screws separately
- > Aluminium
- > Order qty: 1 pc



	length	Hole centres	Cat. No.
Brushed copper	200 mm	160 mm	126.17.230
	300 mm	256 mm	126.17.231
	400 mm	320 mm	126.17.232

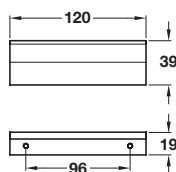

Note: ± 3 mm tolerance on non-critical dimensions and ±1 mm on hole centre dimensions

RUBY trim handle

- > 2x Ø 3.0 x 13 mm countersunk head screws included
- > Brass
- > Order qty: 1 pc



	Cat. No.
Polished nickel	112.84.024
Polished nickel	112.84.724



Don't forget to order M4 handle screws, see page **353**

For our full range of fixing materials and installation tools see the Installation & Display section, pages **350-353**

Rita

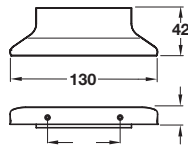
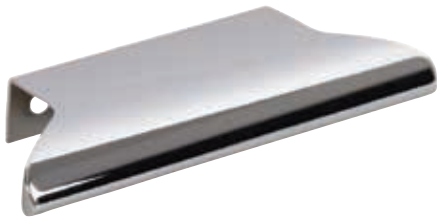

- included
- > Zinc alloy
- > Order qty: 1 pc



	Cat. No.
	126.45.050
	126.45.051
 Matt black	126.45.052

Dimensional data not binding. We reserve the right to alter specifications without notice.

AT A GLANCE

KITCHEN APPLICATIONS

BEDROOM APPLICATIONS

BATHROOM APPLICATIONS

HANDLE FREE APPLICATIONS

INSTALLATION & DISPLAY

GOLA Profiles for Handle Free A

Profiles for recess mounting in the cabinet carcass to create a stream

Gola Profile systems are ideal to achieve a design. Compared to more traditional cabin give a flush-fitting, handle-less style. You c similar tone to the cabinet for a seamless fi will make more of a contemporary design s

Our on-trend range of complementary Gola maximum style and functionality.

There are six different systems in a choice to suit a variety of different applicat

Key features:

- > Choice of 7 finishes; anodised or powder coa
- > High quality, on trend design
- > Extensive variety of options

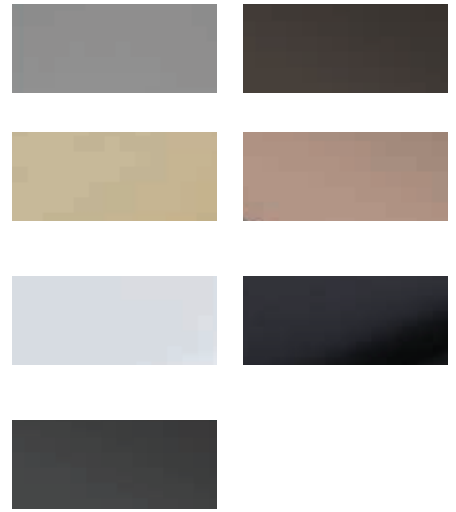

System B Plus, System C Plus, System D and System E profiles with aluminium plinth profile, graphite powder coated finish



System B Plus and System C Plus profiles,
silver anodised finish



System B Plus and System C Plus profiles with aluminium plinth profile,
brushed copper anodised finish

Dimensional data not binding. We reserve the right to alter specifications without notice.



GOLA system profiles are available for different applications where a streamlined handle free look is required.

- > **System A:** For horizontal fixing under wall units; page **339**
- > **Original system B:** For horizontal fixing under worktops, with plastic connectors; page **340**
- > **Original system C:** For horizontal fixing between doors and drawers, with plastic connectors; page **341**
- > **System B Plus:** For horizontal fixing under worktops, with aluminium profile connectors; page **342**
- > **System C Plus:** For horizontal fixing between doors and drawers, with aluminium profile connectors; page **343**
- > **System D and E:** For vertical fixing between doors; pages **344-345**

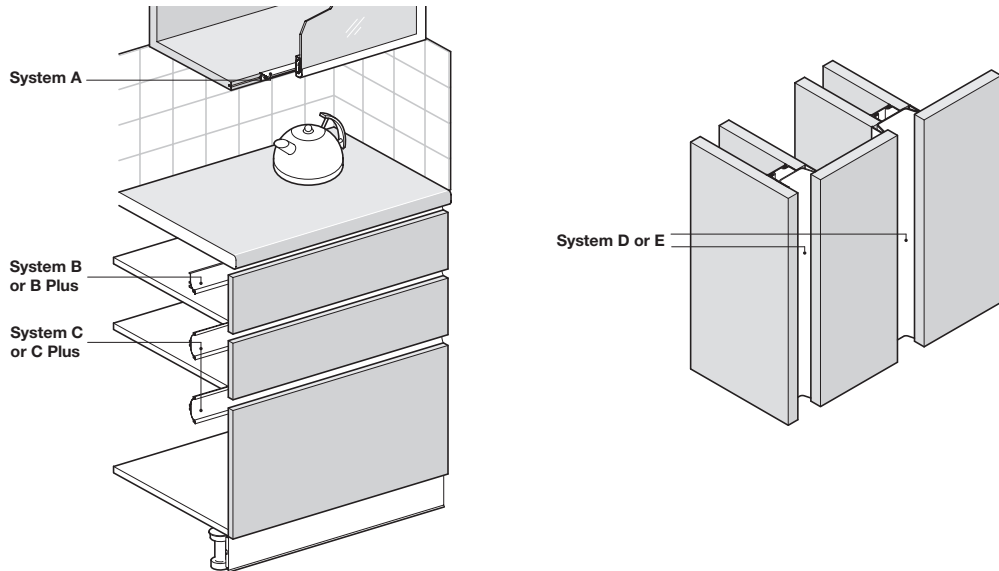

Please note: The Gola profile dimension does not allow for use with a fully integrated dishwasher, the profile stops at the dishwasher. The dishwashers door will need a handle

EXAMPLE SYSTEM SELECTION				
Item description	Order qty	Finish	Cat. No.	Page
GOLA System A - Horizontal fixing under wall units				
Profile for horizontal fixing under wall units, without soft lip shock absorber	3.9 m length	Silver anodised aluminium	126.48.900	339
Profile for horizontal fixing under wall units, with soft lip shock absorber	3.9 m length	Silver anodised aluminium	126.48.910	339
Profile for horizontal fixing under wall units, with slot for LED strip	4.1 m length	Silver anodised aluminium	126.48.920	339
GOLA Original System B - Horizontal fixing under worktops, with plastic connectors				
Profile for horizontal fixing under worktops	3.9 m length	Silver anodised aluminium	712.63.900	340
Profile connector	1 pair	Red plastic	712.63.511	340
Profile connector with end panel cover	1 pair	Black plastic	712.63.510	340
Exterior trim caps	1 pair	Grey plastic	712.63.540	340
Interior trim caps	1 pair	Grey plastic	712.63.541	340
Internal/external corner for profile	1 pair (1x internal, 1x external)	Grey plastic	712.63.530	340
GOLA Original System C - Horizontal fixing between doors and drawers, with plastic connectors				
Profile for horizontal fixing between doors and drawers	3.9 m length	Silver anodised aluminium	126.47.900	341
Profile connector, screw fixing	1 pair	Red plastic	712.63.511	341
Profile connector, dowel fixing	1 pair	Red plastic	712.63.521	341
Exterior trim caps	1 pair	Grey plastic	126.47.590	341
Interior trim caps	1 pair	Grey plastic	126.47.591	341
Internal/external corner for profile	1 pair (1x internal, 1x external)	Grey plastic	126.47.592	341
GOLA System B Plus - Horizontal fixing under worktops, with profile aluminium connectors				
Profile for horizontal fixing under worktops	4.1 m length	Silver anodised aluminium	126.36.940	342
Trim caps	1 pair	Silver anodised aluminium	126.36.947	342
Profile connector for internal corners	1 pair	Silver anodised aluminium	126.36.946	342
Profile connector, screw fixing	1 pair	Red plastic	712.63.511	342
Profile connector, dowel fixing	1 pair	Red plastic	712.63.521	342
GOLA System C Plus - Horizontal fixing between doors and drawers, with profile aluminium connectors				
Profile for horizontal fixing between doors and drawers	4.1 m length	Silver anodised aluminium	126.36.950	343
Trim caps	1 pair	Silver anodised aluminium	126.36.986	343
Profile connector for internal corners	1 pair	Silver anodised aluminium	126.36.985	343
Profile connector for external corners	1 pair	Silver anodised aluminium	126.37.916	343
Profile connector, screw fixing	1 pair	Red plastic	712.63.511	343
Profile connector, dowel fixing	1 pair	Red plastic	712.63.521	343
GOLA System D - Vertical fixing between doors				
End profile for vertical fixing between cabinet and door	2.67 m length	Silver anodised aluminium	126.36.972	344
Profile for vertical fixing between doors	2.67 m length	Silver anodised aluminium	126.36.962	344
Profile for vertical fixing between cabinet and oven	2.67 m length	Silver anodised aluminium	126.38.910	345
Vertical profiles, spacer set for vertical profiles	1 set	Zinc plated steel	126.36.958	345
GOLA System E - Vertical fixing between doors				
End profile for vertical fixing between cabinet and door	2.4 m length	Silver anodised aluminium	126.37.962	346
Profile for vertical fixing between doors	2.4 m length	Silver anodised aluminium	126.37.942	346
Profile for vertical fixing between cabinet and oven	580 mm length	Silver anodised aluminium	126.37.891	347
Co-ordinating aluminium plinths				
Plinth panel	3.0 m length	Silver anodised aluminium	713.35.401	349
Plinth protector, linear	1 pair	Silver anodised aluminium	781.34.996	349
Plinth connector, 90° or end connector	1 pair	Silver anodised aluminium	781.34.997	349
Plinth clip	1 set	Black plastic	713.28.540	349

GOLA Original System C Plus dishwasher frame

To create the linear look of the kitchen. For fixing between the dishwasher front and the dishwasher doors

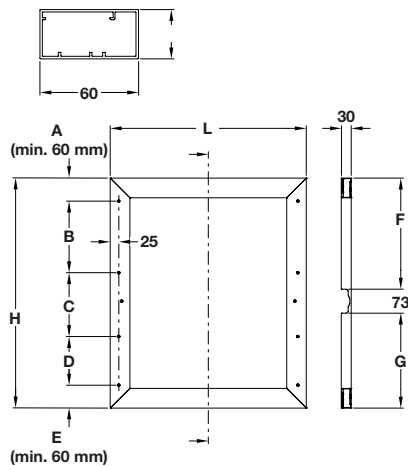

GOLA System C Plus dishwasher frame

- > To create the linear look of the kitchen, why not use the GOLA System C Plus profile even on the dishwasher door
- > To be fixed between the dishwasher front and the dishwasher doors
- > Anodised aluminium with a stainless steel look to match the dishwasher front
- > Order qty: 1 pc (1 pc = 580 mm length)



Length x Width	Cat. No.
690 x 596 mm	126.36.730

- ➔ Order System C Plus profile section and end caps separately, shown on page 343

GOLA System A

For horizontal fixing under wall units

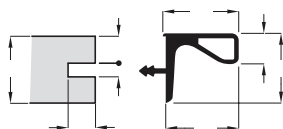
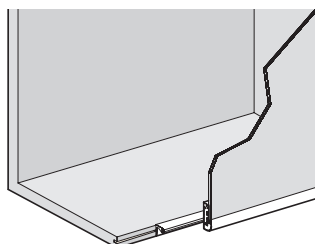

●	00

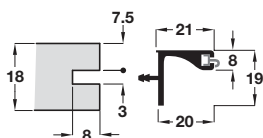
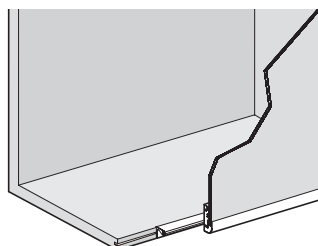

●	126.48.910

GOLA System A profiles, for horizontal fixing under wall units, with slot for LED strip

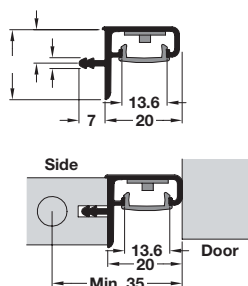
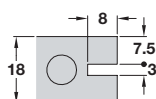
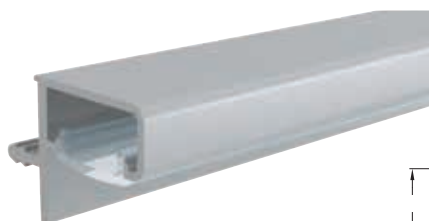

●	126.48.920

Dimensional data not binding. We reserve the right to alter specifications without notice.

GOLA Original System B

For horizontal fixing under worktops, with plastic connectors

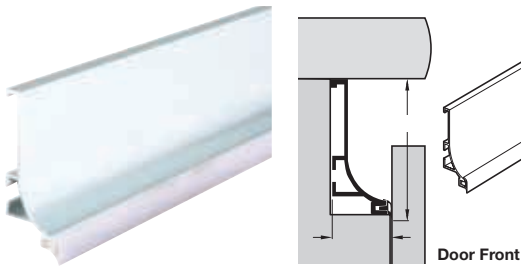

GOLA Original system B profile, for horizontal fixing under worktops

- > For fixing between the worktop and door or drawer d aluminium
- y: 1 pc (1 pc = 3.9 m length)

Type	Cat. No.
Anodised	712.63.900

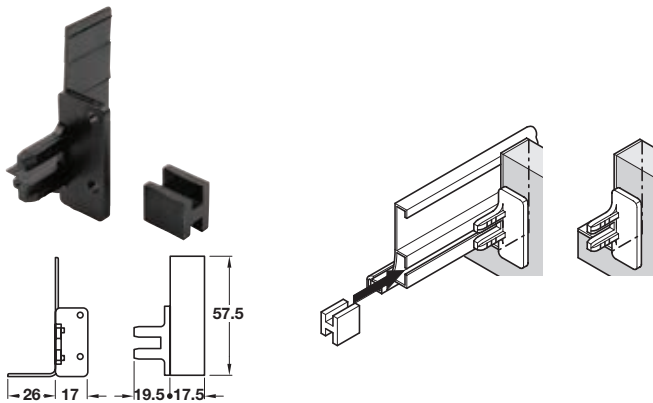

GOLA Original system B profile connector with end panel cover

- > For connecting profile to cabinet inside panel
- > With end panel cover
- > Black plastic
- > Order qty: 1 pair

Type	Cat. No.
Screw fixing	712.63.510



Order connectors and caps separately, shown below

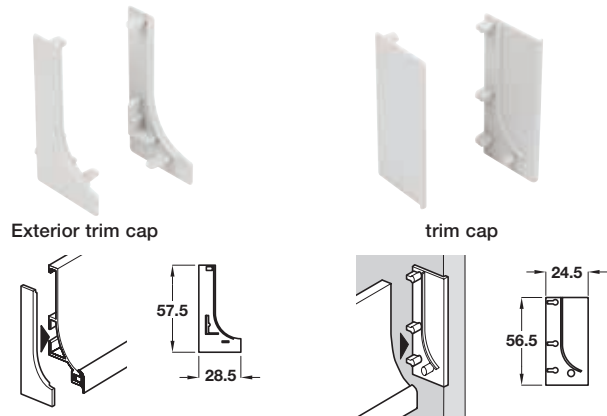

Exterior trim cap

trim cap

GOLA Original system B profile trim caps

- > Grey plastic
- > Order qty: 1 pair

Type	Cat. No.
Exterior trim caps	712.63.540
Interior trim caps	712.63.541

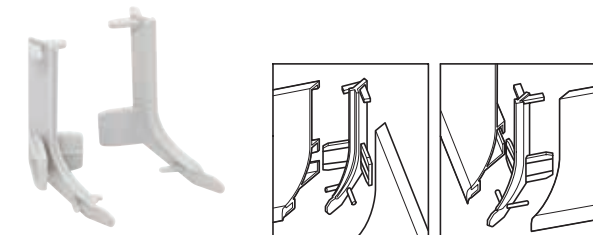

Internal/external corner for profile

- > For connecting profile, for internal or external corners
- > Grey plastic
- > Order qty: 1 pair (1x internal, 1x external)

Type	Cat. No.
Corner for profile	712.63.530

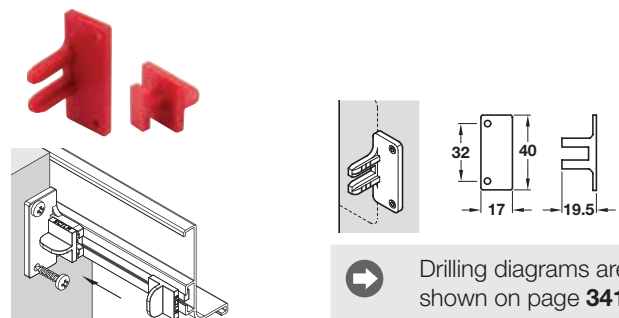

Drilling diagrams are shown on page 341

GOLA System B/C Plus profile connector

- > For connecting profile to cabinet inside panel
- > Red plastic
- > Order qty: 1 pair

Type	Cat. No.
Screw fixing	712.63.511

GOLA Original System C

For horizontal fixing between doors and drawers, with plastic connectors

➔ Order connectors and caps separately, shown below

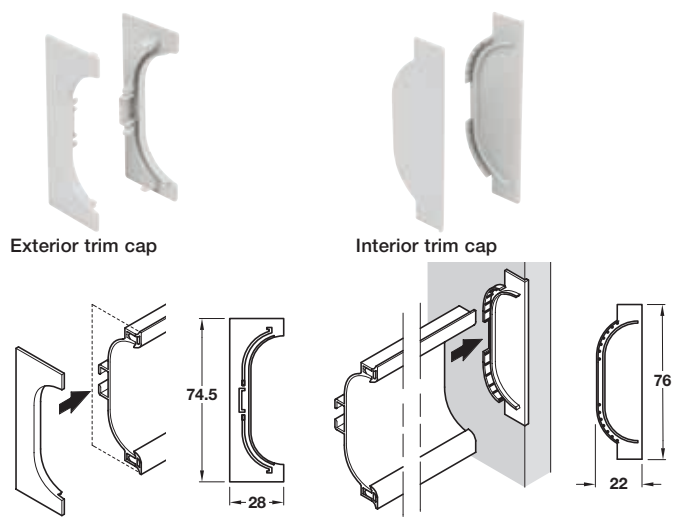
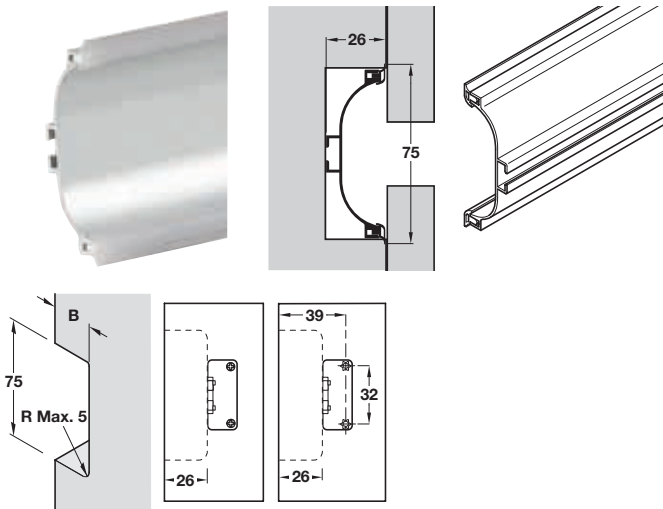

GOLA Original system C profile, for horizontal fixing between doors and drawers

- > For fixing between doors and drawers of aluminium
- > 1 pc (1 pc = 3.9 m length)

GOLA Original system C profile trim caps

- > Grey plastic
- > Order qty: 1 pair

	Cat. No.
● Anodised	126.47.900

Type	Cat. No.
Exterior trim caps	126.47.590
Interior trim caps	126.47.591



Screw fixing

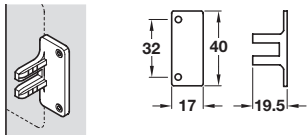

Dowel fixing

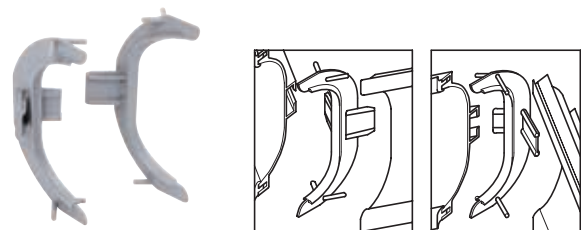
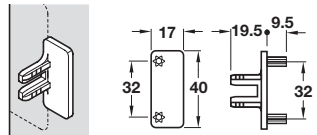

Internal/external corners

- > For connecting profiles, for internal or external corners
- > Grey plastic
- > Order qty: 1 pair (1x internal, 1x external)

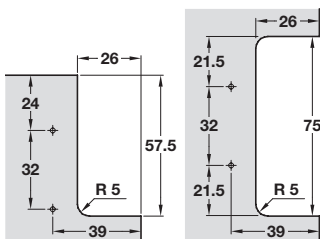

Screw fixing drilling diagram

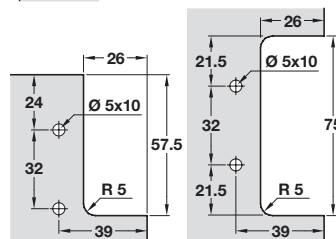

Dowel fixing drilling diagram

Type	Cat. No.
Internal/external corners	126.47.592

GOLA System B/C profile connector

- > For connecting profile to cabinet inside panel
- > Screw or dowel fixing
- > Red plastic
- > Order qty: 1 pair

Type	Cat. No.
Screw fixing	712.63.511
Dowel fixing	712.63.521

Dimensional data not binding. We reserve the right to alter specifications without notice.

GOLA System B Plus

For horizontal fixing under worktops, with profile aluminium connectors

➔ Order connectors and caps separately, shown below

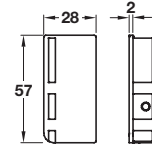
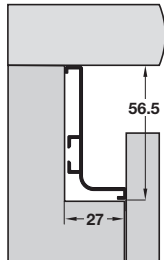

Matt black pow	

	126.36.947
	126.36.180
	126.36.780
	126.36.589
	126.36.880
	126.36.948
Matt black powder coated	126.36.949



Design may differ;
function is not
affected

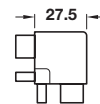
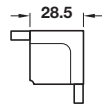

Matt black pow	

	126.36.945
	126.36.182
	126.36.782
	126.36.587
	126.36.882
	126.36.944
Matt black powder coated	126.36.943

GOLA System C Plus

For horizontal fixing between doors and drawers, with aluminium profile connectors



Order connectors and caps separately, shown below

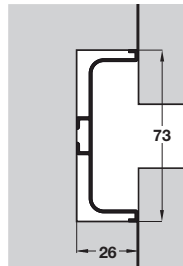

e, for horizontal fix

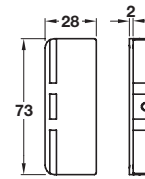

Matt black pow	

	126.36.986
	126.36.183
	126.36.783
	126.36.560
	126.36.883
	126.36.987
Matt black powder coated	126.36.988

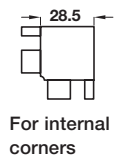

For internal corners

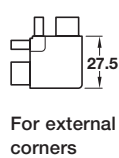

For external corners



Screw fixing

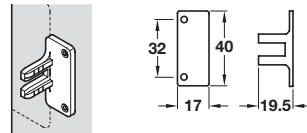

Dowel fixing

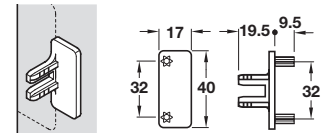

		126.37.916
		126.37.915
		126.37.917
		126.37.920
		126.37.919
		126.37.914
Matt black powder coated	126.36.983	126.37.913

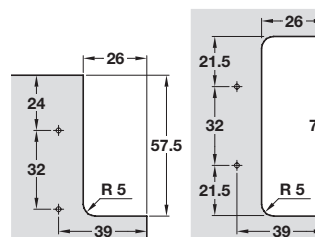

Screw fixing drilling diagram

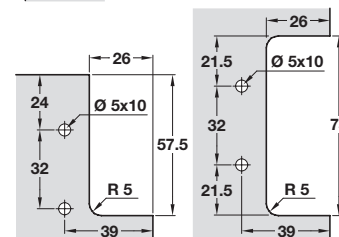

Dowel fixing drilling diagram

GOLA System B/C Plus profile connector

- > For connecting profile to cabinet inside panel
- > Screw or dowel fixing
- > Red plastic
- > Order qty: 1 pair

Type	Cat. No.
Screw fixing	712.63.511
Dowel fixing	712.63.521

GOLA System D

For vertical fixing between doors

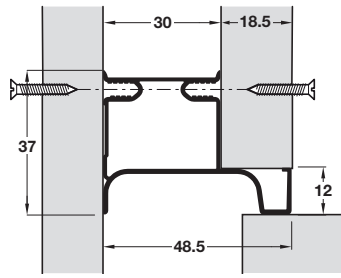

G
fo

ofile,
en cabinet and door

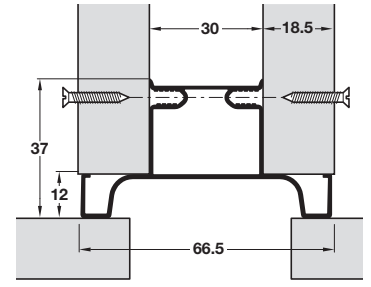

G
fo

en doors



●	
●	
●	
●	
●	
●	
●	



●	
●	
●	
●	
●	
●	
●	



When cutting aluminium a normal chop saw with a good blade for aluminium is needed
 As a final step, a fine polishing with sanding paper is usually required as well as cleaning with compressed air



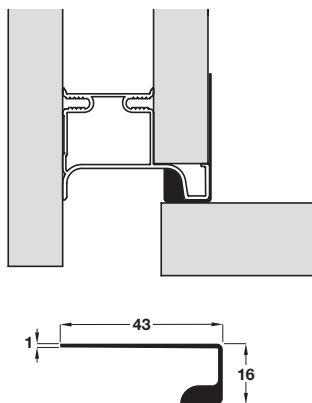

**GOLA System D profile,
for vertical fixing between cabinet and oven**



	126.38.910
	126.38.810
	126.38.710
	126.38.511
	126.38.110
	126.38.912
Matt black powder coated	126.38.913
	rs profile)

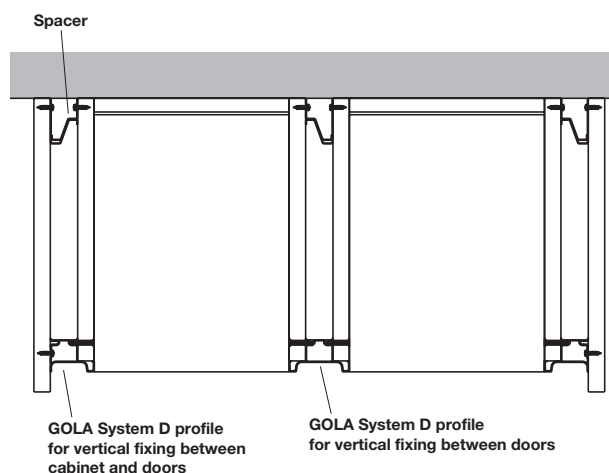
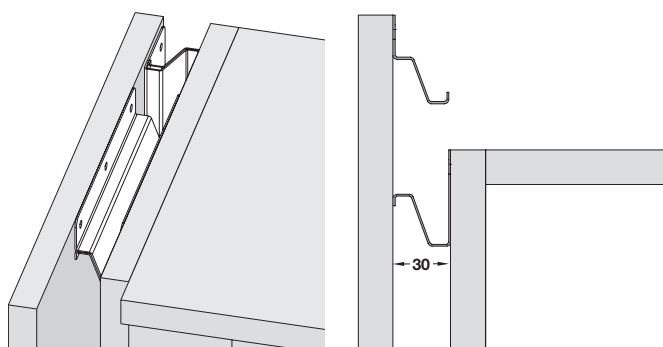

Spacer set for System D vertical profiles

- > Spacer set for System D vertical profiles, to provide 30 mm rear spacing
- > Set includes:
 - 1x left hand bracket, 30 x 150 mm
 - 1x right hand bracket, 30 x 150 mm
 - 6x Ø 3.5 x 16 mm screws, zinc plated steel
- > Zinc plated steel
- > Order qty: 1 set



Type	Cat. No.
Spacer set	126.36.958

For use with GOLA System D vertical profiles, shown on page **344**

GOLA System E

For vertical fixing between doors

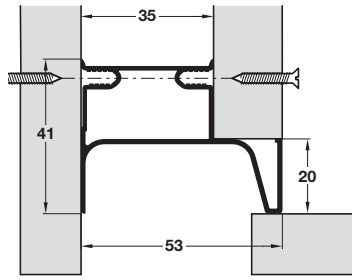

GO
for

rofile,
een cabinet and door

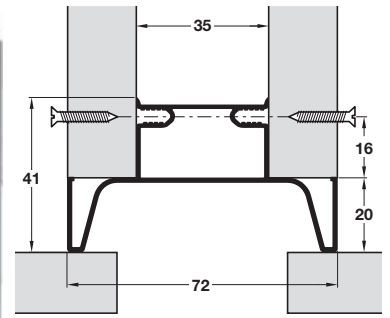

en doors





	126.37.942
	126.36.132
	126.37.742



When cutting aluminium a normal chop saw with a good blade for aluminium is needed
As a final step, a fine polishing with sanding paper is usually required as well as cleaning with compressed air

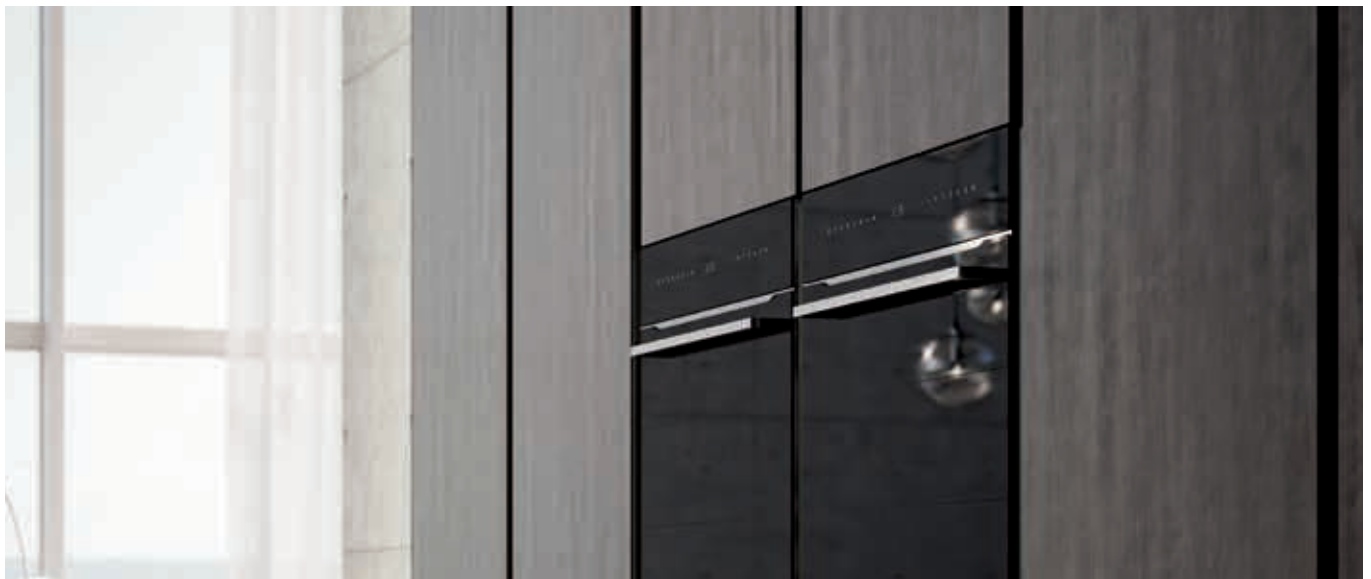

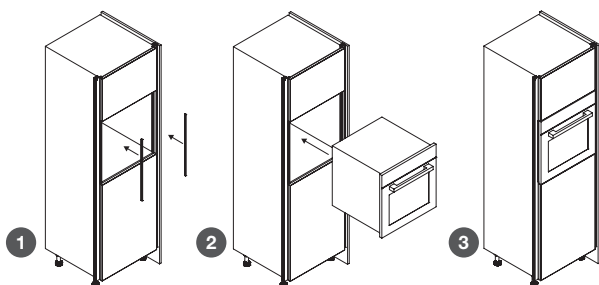
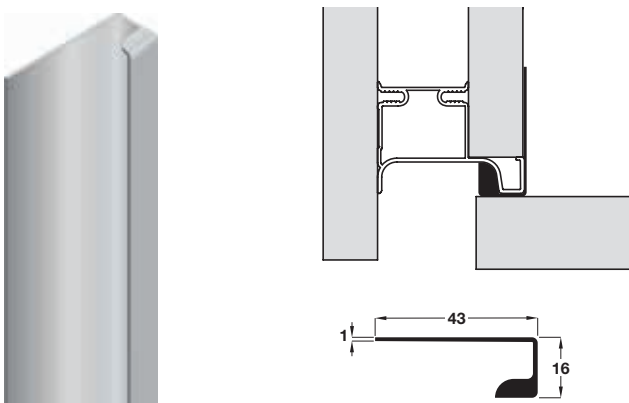

**GOLA System E profile,
for vertical fixing between cabinet and oven**

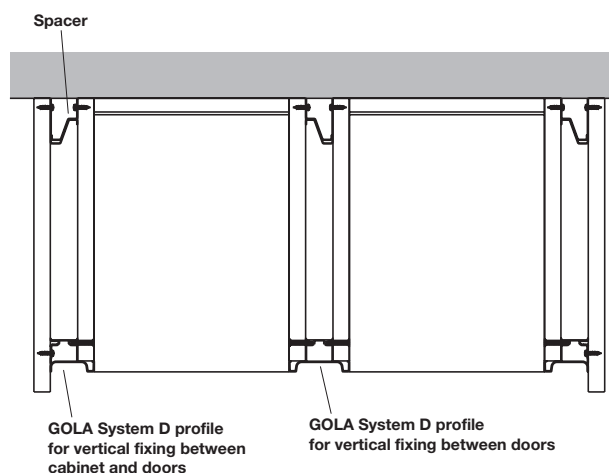
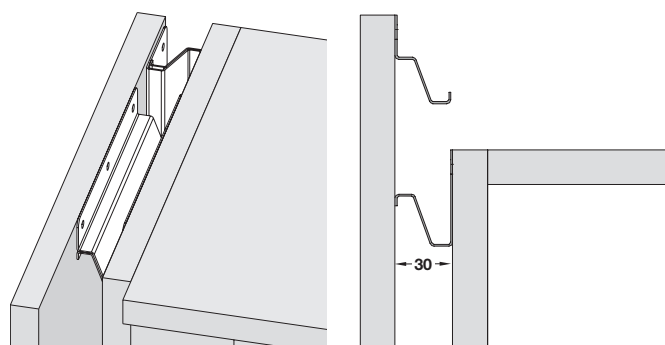

Spacer set for System E vertical profiles

- > Spacer set for System E vertical profiles, to provide 30 mm rear spacing
- > Set includes:
 - 1x left hand bracket, 30 x 150 mm
 - 1x right hand bracket, 30 x 150 mm
 - 6x Ø 3.5 x 16 mm screws, zinc plated steel
- > Zinc plated steel
- > Order qty: 1 set



Type	Cat. No.
Spacer set	126.36.958



	126.37.891
	126.37.890
	126.37.892
	126.37.897
	126.37.894
	126.37.895
Matt black powder coated	126.37.896

between 346

Use spacer Cat. No. 126.36.958 for the system E profiles alongside the use of washers, shown left



Graphite powder coated version shown

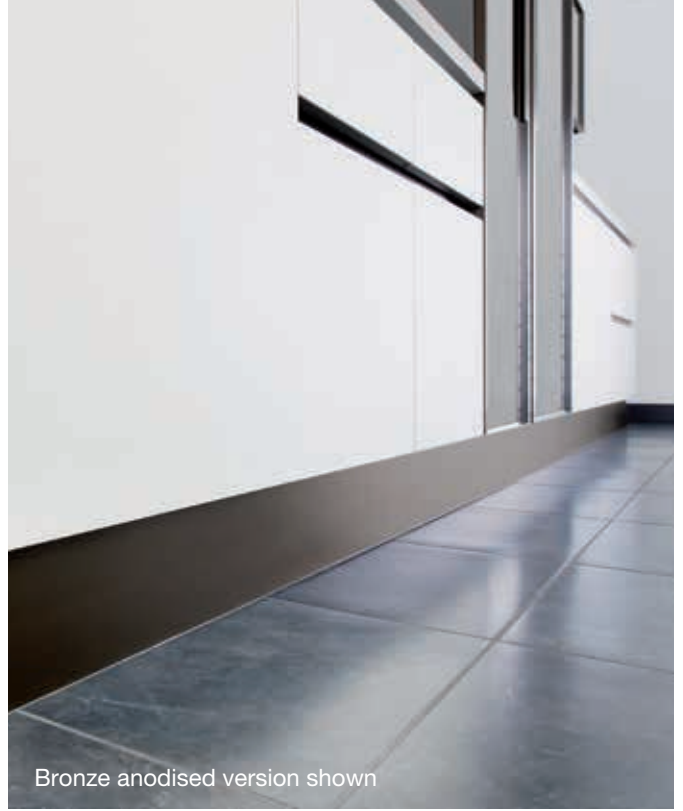

Bronze anodised version shown



Brushed copper anodised version shown



Brushed brass anodised version shown

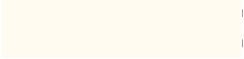

Order plinth connectors and clips separately, shown below

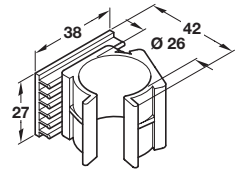
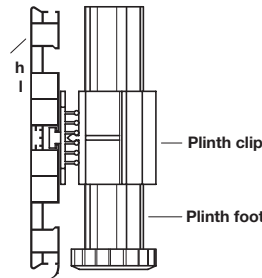

	713.35.401
	713.35.101
	713.35.301
	713.35.601
Brushed copper anodised	713.35.801

Plinth clip

- > For use with PVC plinth panel 713.28.515
- > Can also be used with aluminium plinth panel shown above
- > Plastic
- > Order qty: 1 set (order in multiples of 12 sets)

Finish	Cat. No.
Black	713.28.540

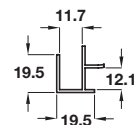
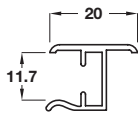

Brushed copper anodised	

	781.34.997
	781.34.197
	781.34.397
	781.34.697
Brushed copper anodised	781.34.897

Installation Tools

A simple jig which accurately marks out door and drawer fronts in preparation for fixing handles and knobs

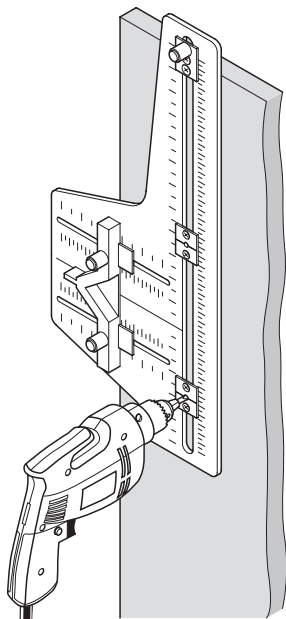

For drilling on doors or flaps

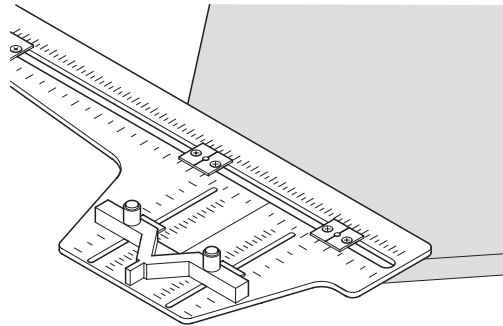

For drilling on flaps at 45° angle

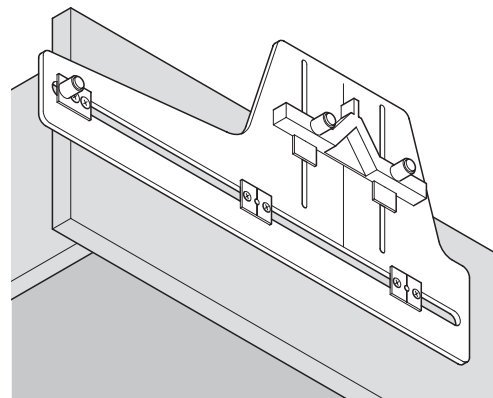

For drilling on panels

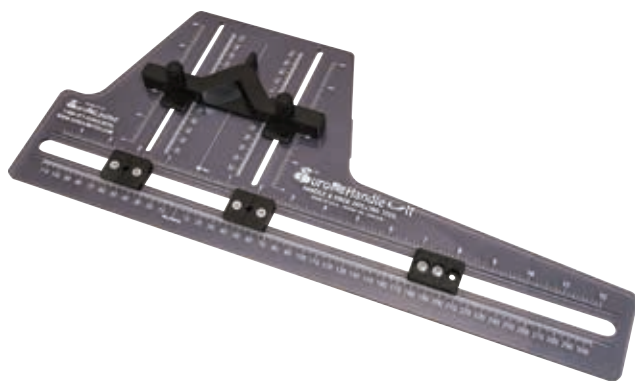

Handle and knob drilling jig

- > V-notch in fence for use in installing handles at a 45° angle
- > Imperial and metric scales for use on all handles
- > Height adjustment to the centre of a 300 mm high drawer front
- > Movable positioning stop for use on drawer fronts of the same size
- > Installs handles as large as 600 mm
- > Made of polycarbonate (jet aircraft canopy material), this jig is virtually unbreakable
- > Order qty: 1 pc

Item	Cat. No.
Drilling jig	001.35.001



Step 1
Firstly, determine the distance from the top of the door where the first hole is required



Step 2
Then determine the distance from the side of the door where the first hole is required



Step 3
Using either a 2 mm pilot drill bit or an awl, mark the door where the first hole is required



Step 4
For a standard centre, simply off the scale the desired hole centres and mark the door with the position of the second hole



Step 5
The jig is now set up for all doors in the kitchen and each door can quickly be marked out ready for drilling



Handle jig

- > Simple jig which accurately marks out door and drawer fronts in preparation for fixing handles and knobs
- > Green/black plastic - colour may vary
- > Order qty: 1 pc

Item	Cat. No.
Door handle jig	001.35.030

Care & Maintenance

We advocate the use of a dry cloth only to clean handles. Please do not under any circumstances use any form of metal cleaner or aerosol spray. Our microfibre cloth is perfect for cleaning all types of handles and knobs without using chemicals that could damage the surface finish



AluSplash microfibre cloth

- > 310 x 285 mm
- > Perfect for use with VuPlex® plastic cleaner
- > Order qty: 1 pc

Colour	Cat. No.
Blue	007.32.135

Handle Display Boards



Handle display boards

- > Light grey MDF
- > Handles not included
- > Order qty: 1 pc

Handle board	Height x Width	Cat. No.
Small	500 x 500 mm	Special order
Large	1000 x 500 mm	Special order

➔ Speak to your Account Manager for more information

Handle Screws and Pins

Don't forget to order your non-metric cut off screws or round-head metal pins

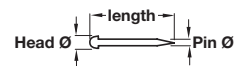
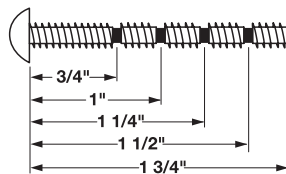

Round-head metal pin

- > Steel
- > Order qty: 1 x 0.5 kg pack = approx. 10,000 pins

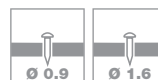

Finish	Head Ø x Pin Ø x Length	Cat. No.	Order Qty
Nickel plated	1.8 x 0.9 x 11 mm	076.40.217	1x 0.5 kg pack
	3.0 x 1.6 x 15 mm	076.40.299	
Brass plated	3.0 x 1.6 x 15 mm	076.40.191	1x 0.5 kg pack

Length	Cat. No.	Order Qty
3/4 - 1 3/4"	022.24.881	100

Handle Screws

Don't forget to order your M4 handle screws



! Please order screws in multiples of order quantity shown



M4 handle screw, standard pack

- > Flat head, with combi-cross slot
- > Zinc-plated steel
- > *45 and 50 mm lengths with 35 mm thread lengths



Length	Cat. No.	Order Qty
M4 x 9 mm	022.35.090	100
M4 x 10 mm	022.35.109	100
M4 x 12 mm	022.35.127	100
M4 x 15 mm	022.35.154	100
M4 x 18 mm	022.35.181	100
M4 x 20 mm	022.35.207	100
M4 x 22 mm	022.35.225	100
M4 x 23 mm	022.35.234	100
M4 x 25 mm	022.35.252	100
M4 x 26 mm	022.35.261	100
M4 x 28 mm	022.35.289	100
M4 x 30 mm	022.35.305	100
M4 x 32 mm	022.35.323	100
M4 x 35 mm	022.35.350	100
M4 x 38 mm	022.35.387	100
M4 x 40 mm	022.35.403	100
M4 x 45 mm	022.35.458*	100
M4 x 50 mm	022.35.501*	100



M4 handle screw, bulk pack

- > Flat head, with combi-cross slot
- > These bulk packs offer great value
- > Zinc-plated steel



Length	Cat. No.	Order Qty
M4 x 9 mm	022.45.090	5000
M4 x 20 mm	022.45.207	5000
M4 x 22 mm	022.45.225	5000
M4 x 23 mm	022.45.234	5000
M4 x 25 mm	022.45.252	5000
M4 x 28 mm	022.45.289	5000
M4 x 32 mm	022.45.323	5000
M4 x 35 mm	022.45.350	5000
M4 x 38 mm	022.45.387	5000

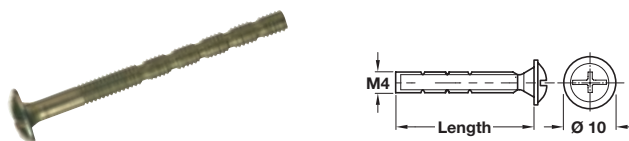

M4 snap off screw

- > Flat head, with combi-cross slot
- > Due to segmentation, screw can be broken at 5 mm increments, shortest length 20 mm
- > Yellow chromated steel



Length	Cat. No.	Order Qty
M4 x 20-45 mm	022.35.887	100
M4 x 20-45 mm	022.35.888	50